



HOW TO PLAY BASKETBALL FOR BEGINNER COACHES AND PLAYERS

*BY STUART MANWARING
FIBA OCEANIA
ZONE DEVELOPMENT OFFICER
AUGUST 2003*

CONCEPTS AND PRINCIPLES OF TEAM OFFENCE AND DEFENCE

All players need to learn the concepts and principles of offence and defence. These principles apply to all types of offence and defence. With a good understanding of and an ability to play these, a player will be able to play all types of offences and defences. Without this understanding and ability a player becomes robotic or premeditates his actions.

There are 3 areas for a player to develop: *SKILLS, UNDERSTANDING HOW TO PLAY and DECISION MAKING*. Of these 3 areas, the most important for a player to learn initially are understanding how to play and decision making. Skills take a much longer period to develop (approx 10 years to develop all skills to a high level), however they should obviously start to be introduced early in development to allow the player to have some competence and confidence in playing.

These concepts and principles apply to all court and field sports and all net sports.

OFFENCE

Concept

The concept of offence is: ***take the ball to open spaces***. Whether passing, dribbling or shooting, always take the ball into an open space, away from the defence.

Principles:

Playing without the ball (a player spends most of the game playing without the ball and so what he does without the ball is most important).

- Always move away from your defence into an open space (be available for the ball)
- Use peripheral vision to see your defence, the ball and the court to make good decisions (the more you can see, the better can be your decision making)
- Move away from the ball, or away from an area, to create space for you, or a team mate, to move into
- Always turn (pivot) to see the court and the basket (never turn to see the outside of the court)
- Use change of direction to move into space (basketball is a game of angles). Create good passing angles by using a change of direction
- Use correct footwork to move and change direction. Point your foot where you want to move; step with your right foot to go right and with your left foot to go left (gives distance on the step and maintains balance)
- Use a quick first and second step to beat an opponent. Basketball is a game of beating an opponent with a one step in offence and defence. A quick first step and second step is more important than speed up and down the court
- Basketball is a movement game, not a game for statues. We move in 3 ways – walk, run and sprint. Walk and then explode is better than run, run, run (helps with timing also)
- Basketball is a running game – ie one foot on the floor at a time (in offence and defence). It is not a skipping, hopping, jumping, dancing game
- Always play with legs flexed (bent) to have immediate power available for movement. If you straighten your legs (stand up), you will need to bend them again to move – this makes you slow to react
- Play with your head in the middle of your body and keep it still. Do not swivel it from side to side to change your vision, instead open up your feet to see more
- Pivoting is used in almost every basketball skill
- Use good spacing (12 - 15 feet/4 - 5 metres apart) to spread the court (and the defence) to create space to move into
- Have good court balance (at least 2 players on each side of the court) to allow for good spacing and to be able to reverse the ball from side to side, and to allow for a safety player out top
- Keep it simple – basketball is a simple game, do the simple things that work. There are no points in basketball for “style”
- Teamwork is played by players without the ball. Communication is the key to all good teamwork. By leaving an area a player creates space for another player to come into (with or without using a screen). This creates movement of players and can be up and down the court (ie on one side of the court) or across the court (ie using the width of the court)

Playing with the ball

- Receiving the ball going away from the basket, square up taking the ball to the hip area of the free foot (the non pivot foot), ready to pass, dribble or shoot, in that order
- Receiving the ball going toward the basket, square up taking the ball to the shoulder of the free foot (the non pivot foot), ready to pass, shoot or dribble, in that order
- Always pass to a player who is moving (if he stops and the defence keeps moving, the defence will end up with the ball)
- Good passing teams are those that pass the ball to players in open spaces (away from the defence), not necessarily those that are technically correct
- Ball movement is important. The defence reacts (adjusts) to the movement of the ball first and player movement second
- Ball reversal is the single most potent weapon to beat good defence
- Manage the ball well (look after the ball) in crucial situations (at the end/beginning of a quarter and at the end of the game, or when the other team is applying pressure). The team with the less turnovers is usually the team that wins

DEFENCE

Concept

The concept of defence is: **stop the ball**. Stop the ball from getting closer to the scoring area. It is the ball we must stop, not players, as it is the ball that scores.

Principles

Playing on-ball

- Play between the ball and the basket (not between the player and the basket)
- Always move with the ball (at the same time as the ball) and in the same direction as the ball (parallel to the ball movement)
- Force the ball away from the 80% scoring area (the lane/key) and toward the sideline (enables the defence to deny passes into the lane and force the ball out on top – away from the basket)
- Give up an outside shot in favour of protecting against a shot in the lane/key

Playing off-ball

- Always play the principles of “help and recover defence”, the basic principles of all team defences
- Always play in a triangle between your player (or the player/s in your area in a zone defence) and the ball. The closer your player is to the ball, the flatter is your triangle and the closer you should be to your player. The further your player is from the ball, the deeper is your triangle and the further you can be from your player
- Always see your player and the ball (do not look at the ball) and the court
- Always move with the ball (at the same time as the ball) and in the same direction as the ball (parallel to the ball movement)
- When your player is on the ball side of the split line (the imaginary line between the two baskets – “splits” the court into ball side and help side), play in a flat triangle toward your player. When your player is on the help side, play in a deeper triangle, further from your player, with at least one foot on the split line. Always help against penetration of the ball into the lane/key from the help side. Never help from the ball side
- Recognise that the most dangerous offensive player is the player with the ball. The second most dangerous player is the player closest to the ball and/or basket. The next most dangerous player is that next closest to the ball/basket, etc. Protect against the most dangerous and second most dangerous first
- When your defence breaks down on a turnover or against a fast break play “Scramble Defence” principles (refer to the notes on the most dangerous player above)

BASKETBALL FOR BEGINNERS

The basic concept of offence.

Many sports have the same basic concept of offence - *take the ball to the open spaces, away from the defence, to be able to score more easily*. These sports include all field and court sports and include the net sports (tennis, badminton, and volleyball).

It seems logical to teach the concept first and yet many basketball coaches (and those in other sports) fail to teach this concept at the beginning. Basketball is no different than most other things we learn in life, in that if we do not understand the concept of what is being taught then we shall have trouble trying to relate the more complex tasks involved in solving problems in that subject. So often coaches try to teach players in the early stages *what to play* and not *how to play*.

Have you ever seen two teams of 9 or 10 years old children learning to play soccer? The field is big; the ball is small and where are all the players? Gathered around the ball, like ants around a pot of honey.

Why? Because every player wants to get the ball, but no one can, except through some lucky break. While all of the offensive players are all gathered around the ball so are the defensive players and so good passing becomes impossible and scoring is out of the question.

Now cast your mind to Championship Division soccer. Here the players in offence are spread out over almost the entire field and the ball is passed into spaces, away from the defence and scoring becomes imminent.

The same examples can be made in basketball, and unfortunately for many players who are not taught the concept of offence they continue to gravitate toward the ball even as senior players and this is why the passing and shooting skills look so poor at lower standards of the game. In fact the technique of the skills of passing and shooting may be very good, but a lack of understanding of the concept of offence causes the skills to look poor. Moving the ball to players in open space makes a team look good at passing and shooting, even if their technique is not too good.

Take the ball to the open spaces, away from the defence, to be able to score more easily! By taking the ball to an open space, away from the defence, whether passing, dribbling, shooting or protecting the ball, the defence is forced to adjust and any failure in adjusting quickly will present opportunities to the offence for scoring. Obviously this means that all players without the ball must be continually moving into open spaces, away from the defence. This creates two problems for the defence, regardless of which style of defence they may play (man-to-man or zone).

Firstly, the defensive players away from the ball must be continually adjusting (re-active defence) or they will allow offensive players to move into scoring positions. Secondly the defence is not in a position to create much pressure on the ball and if it tries to do so (pro-active defence) then the offence can move the ball to a player in a scoring position.

Playing basketball is a bit like playing draughts - at 100 miles per hour! One player makes a move (the offence) and the other player tries to counter this move (the defence). At the lower standard of play a draught player counters a move by reacting to the opponent (re-active defence). At a higher standard the player counters by making aggressive moves to force the opponent to react (pro-active defence). Draught players must be continually aware of where the open spaces are and by moving the playing pieces force the opponent into giving up a playing piece and therefore getting to the end of the board (scoring). It is the same in basketball. At the lower standards of play the defence is usually re-active and at the higher levels more likely to be pro-active.

In my opinion there are THREE main steps to developing a basketball player (and it is the same for most sports):

1. Understanding the BASIC CONCEPTS AND PRINCIPLES OF OFFENCE and DEFENCE.
2. Teaching good DECISION MAKING - with the ball knowing when and where to move it, without the ball knowing when and where to move oneself. Decision making is a product of good vision. Teaching VISION AND SPATIAL AWARENESS - being aware of the ball and all other players on the court and the spaces around them.
3. Learning the SKILLS of the game – footwork, movement and ball skills.

The great basketball players (and other great athletes) of this world are not necessarily the most athletic or the best skilled, but THEY ARE the BEST DECISION MAKERS. It is important that as we teach players the concepts, principles and the skills that we also teach them to use their vision and make good decisions. All THREE areas need to be developed from the beginning.

Additionally we need to teach from the outset that in the game of basketball (as in most team sports) we spend most of the time playing WITHOUT the ball and it is WHAT we do WITHOUT the ball that is so important. Basketball is a MOVING game, not a game for statues. Unfortunately there are too many statues playing even at the higher levels, example the NBA. In offence a player needs to move to get open, pass and move, move to set a screen or use a screen and move to rebound. In defence a player needs to move to adjust to the ball movement, move to adjust to the offensive player's movement, move to help out, move to switch or hedge on a screen, move to double team or trap or run and jump and move to rebound. Players love to move and that is one of the reasons that they like to play Motion style offences, it allows them more freedom of movement. It is fun to move but it is also so IMPORTANT in this game.

Basketball is a RUNNING game. This means that the player must be continually moving, BUT not always at high speed. In basketball a player uses 3 kinds of movement – WALK, RUN AND SPRINT. The use of EXPLOSIVE speed (SPRINTING), when required, is much more important. In the main a player should WALK and SPRINT more than RUN. We shall discuss these areas in much more detail in the chapter on FOOTWORK.

How to teach the concept of offence through movement and awareness.

So how can we teach this concept in a simple way that will allow players to grasp the concept and have it firmly fixed in their minds as the base from which all offence will develop. The following steps are primarily for teaching this knowledge to young children or beginner players but sometimes they are also worthwhile trying with “experienced” players to see how well they understand and use decision making.

Firstly establish a “court” (area) that is suitable to the number of players you have.

One way is to have the players stand with arms outstretched and move to form a rectangle or square with fingertips touching. Mark the corners and the boundaries with cones or suitable articles. The area does not have to be on a basketball court, and in fact the concept may be taught on any flat surface. Note that a four sided “court” is much better than a circle in that it approximates all court and field sport playing areas (particularly a basketball court) in that it has corners (this reason will be apparent in step 3). Have all players stand within the boundaries of the “court”.

STEP 1 - instruct the players to continually move to an open space on the “court” on the command Go and to “freeze” on the sound of the whistle. Allow about 15 seconds after the command go before blowing your whistle. Observe how some players will be bunched up within the ‘court’ and some players will be spaced away from others. Also observe how well (or poorly) the players have utilised all the open spaces on the “court”. Make these observations known to the players.

STEP 2 - repeat STEP 1 with the additional instruction of continually moving to an open space AWAY from other players. Allow the players to move for about the same length of time and while they are moving observe how some players actually move toward other players to get to an open space. After the players “freeze” on the whistle, observe how well they are spaced apart and comment on this fact and the way that some players moved toward other players to get to an open space. Demonstrate

this to the players and also how by using their vision and awareness they can move AWAY from others to an open space. Now is the time to introduce vision and awareness and to educate them on narrow focus and peripheral vision. Stress that by using peripheral vision (that which is used most of the time in basketball and is so important) in both a horizontal and a vertical plane we can see both the players around us and the open space on the floor.

Point out that in a vertical plane our peripheral vision is much better down than up, due to the structure of our head and the protruding forehead. So by carrying our head up we can clearly see the floor (ground) about 1 - 2 metres ahead. Also point out that our horizontal peripheral vision is about 180 degrees and that we need to see (as compared to look at, which is narrow focus) all that is within our peripheral vision. Instead of turning our head to see to our right or left we should move our feet to open up our stance in that direction. This helps to maintain good peripheral vision and also allows us to have our feet pointed where we may wish to move (this will be taught later in footwork).

STEP 3 - Repeat the instructions for STEPS 1 and 2, emphasising to use vision to see the spaces and other players and add a further instruction to stay out of the corners. In the game of basketball we do not want

the players to play in the corners of the court. These are the areas in which the defence would like to trap the ball, and also it reduces the angles at which the offensive player can move when confronted by a defensive player. In addition we can start to educate the players about the importance of maintaining good spacing away from other offensive players so that the defence is spread and finds it more difficult to create pressure on the ball. Have the players repeat the drill (exercise) and observe how they move.

Through these drills we have started to educate the players on the basic concept of offence and the most important principle of playing without the ball. This is moving away from other players to open spaces to be able to *take the ball to the open spaces, away from the defence, to be able to score more easily*. As with all learning, these drills will require repetition and ongoing correction and in just a few sessions the players will be able to grasp the concept.

In addition to starting to learn the basic concept of offence the players are also starting to understand basic movement and footwork, something which should be highlighted at this point. In the above drills to move to a space and keep away from other players, the player must continually move and change direction. These are important skills in basketball.

To demonstrate this further and to reinforce the concept through playing, the coach can use the following drills (games). As with all learning, instruction (and demonstration) should initially be short and concise and quickly followed by practical application (having the players do it). During the practical application the coach should observe and on completion, correct. As the players show the ability to understand and perform the skill a little better, correction should be more on an individual basis rather than correcting the group as a whole.

TEN PASSES - divide the group into two teams and using an area about the size of half a basketball court (the size of the area needs to be relevant to the number in the group, with 15-20 players on a half court). Have one team attempt to make 10 successful passes between team members while the other team's players try to deflect the ball while it is in the air on a pass. Allow each team two or three tries at completing the **TEN PASSES** before changing the offence to the other team. Highlight the need to continually move to open spaces away from the defence and to pass the ball only to a player moving into an open space. Coaches can start to educate the players on being patient to complete successful passes.

KING BALL - divide the group into two teams and using an area about the size of a basketball court (use a smaller area if there are less than 15 players) and have each team select a **KING** to stand at opposite ends of the court. Without running (travelling) with the ball, each team is to try to pass the ball between their players to move the ball successfully to their **KING**, who must remain standing still. The last pass to the **KING** **must** be a bounce pass. The defensive team must try to prevent the ball from getting to their opponents' **KING** by catching the ball and immediately going into offence or by deflecting the ball out-of-bounds (when the same offensive team then has to pass the ball in-bounds to re-commence the game). Obviously we are simulating the game of basketball and allowing the players to develop their understanding and application of the basic concepts of offence and defence.

The following drills may be used for players who have already been exposed to the game of basketball, but are also excellent drills for teaching to beginner players.

ONE ON ONE FULL COURT - this drill teaches players that to get away from (beat) their opponent they must change direction and move with speed into a space away from their opponent to win. Have the players pair up with one player (the offensive player) standing on the baseline of the basketball court and the opponent (the defensive player) standing about 3 metres inside the court and facing the offensive player. On **GO** from the coach the offensive player tries to beat his opponent to the other end of the court. The defensive player has to try to tag the offensive player on the shoulder twice with the same hand. Reverse roles and come back down the court. Offensive players quickly learn that by using all the space available on the court, moving away from the defence and changing direction they have a better chance of beating their opponent.

TWO ON TWO - basketball is essentially a passing game and so dribbling and scoring are eliminated in this drill. In all drills, the area of the court being used should be relevant to the number of players (ie similar to the amount of space on the court that the same number of players would use in a 5 on 5 game). For this reason we restrict the players to a quarter of the court (ie one side of the ring). Each of the two offensive players, one with the ball, is guarded man to man by a defensive player. The offensive player without the ball must play (read) the defensive player to be able to move away from his defence into a space to be able to receive the ball. The offensive player without the ball must see the ball but not look at it and his vision is primarily used to see his defence and the

spaces available to him. In this way he is able to learn to make good decisions about where to move to, in order to get open for a pass. Some explanation and correction by the coach will be necessary on how to move to create good passing angles.

The offensive player with the ball will need to use his vision to see his teammate and read his own defence and that of his teammate to be able to make good decisions about when and where to pass the ball. Having made a pass, then the passer will become the player without the ball and need to move away from his defence into a space to be able to receive the ball again. The drill continues in this way for 30 seconds, then change the roles of offence and defence. Stress to the offensive players the use of ALL available space on the area of the court being used (that is from baseline to centre line), not always moving toward the basket and playing around the lane (key). Also stress that the player without the ball should move away from the ball to create space to run back into. By continually changing direction to move away from the defence, the offence will be able to get open. Also teach that the offence should change direction to move between the defence and the ball to get to a safe open space to receive the ball.

Once the players have a basic understanding of this concept and principles of movement, the coach should introduce the principles of passing angles. The passing angle is the angle between the offence and the ball and his defence. The wider the angle, the safer is the pass into a space. Another passing angle exists between the offence and the ball and the defence on the player with the ball. To move into a safe space, the offence, without the ball, must observe and use both passing angles.

The longer that players have played the game without understanding the basic concept of offence the more likely they will be to want to move toward the ball to receive it or simply stand still to receive it. Continual correction by the coach will encourage the player to see spaces into which they may move. The larger the area over which the player without the ball moves, the more spaces he will create for himself to run into. Taking one or two steps to get open will only work against poor defence and we should always be teaching our players to play against good defence. Some players will habitually move toward the defence to get open, making it much easier for the defence to defend them. Also some players will start to beat their defence to a spot and then move back toward the defence. The reason for this is that mainly they are focused on the ball and not reading their defence (ie premeditating what they will do, not reacting to what the defence allows then to do).

Before finishing this drill scoring can be added, still without using any dribble, and only from within the lane. In adding scoring the coach should ensure that good shot selection is emphasised and the player without the ball must be open to receive another pass if the defence gets to the potential shooter. Making shots ONLY from open spaces must be stressed (ie NEVER shoot the ball when closely guarded, get it off to a teammate and relocate to another open position).

THREE ON THREE - by building to three on three (using the whole half court – that is playing across the court) and playing in the same way as for two on two, we now challenge the offensive players with more decisions to make. In three on three, the players without the ball need to be aware of where each is moving to create spacing between themselves and to be able to use ALL of the available court space. In addition, each needs to be able to read not only his own defensive player but also that of his teammate without the ball to create good passing angles. The player with the ball now has two team mates he must see, as well as three defensive players, and be able to read which team mate is open first to pass the ball to quickly.

Now the coach can start to educate the offensive players that it is the movement of the ball that creates the defence to initially move and creates spaces for them to run into. Therefore ball movement becomes important, the quicker it moves (without rushing) the more easily the offence can beat the defence.

In addition the coach can introduce the principles of team offence. These should start with maintaining good spacing (at least 3 – 5 metres apart) and court balance (at least one player on each side of the court). Then teamwork can be introduced. Teamwork is played between players without the ball. This requires a player without the ball to communicate (call the name) with the other player without the ball and to initiate movement away from the area and side of the court he is occupying. This then allows the other player to use all of the width of the court (ie exchange sides) to get away from his defence. Similarly when the other player leaves his area the player who communicated and initiated the movement will have more space into which to beat his defence. All movement should still involve changes of direction to get open by seeing (reading) the defence and moving away into space.

Again before finishing this drill scoring can be added, still without using any dribble, and only from within the lane. Continue to stress good shot selection and players without the ball must be open to receive another

pass if the defence gets to the potential shooter. As players learn to better read the defence their shot selection, and therefore their scoring, will improve.

The coach may wish to introduce the use of the dribble in the above drills and if so should emphasise the reasons for using a dribble. There are only two reasons to use a dribble in basketball: to penetrate the ball toward the basket or to improve a passing angle. There is no useful reason to stand still and dribble the ball with an up and down movement, it only increases the chances of the player standing more upright and straightening his legs, therefore decreasing his ability to move quickly from that position. The use of a dribble needs to comply with the basic concept of offence - *take the ball to an open space, away from the defence*. Take the ball with a dribble into an open space to penetrate toward the basket or into an open space on the perimeter to improve a passing angle (this includes the use of a retreat dribble). By reading the defence and not premeditating, the dribbler becomes a potent offensive threat to the defence. Coaches should stress the use of passing on the perimeter as a much quicker way to move the ball than using a dribble.

In just 10 minutes players can be playing a style of basketball that eliminates passing errors, creates more scoring opportunities and is fun to play. I have often found players to be amazed at just what they can accomplish with a basic understanding of the concept of offence. Additionally experienced players benefit from breaking the game down into this very basic format and further assists the coach in developing high work rate and quickness in their game.

FUN DRILLS - every coach should have in his list of drills some that are fun to play, yet still contain components of skills and physical and mental challenges (of a medium level). There are many drills that have been devised by coaches around the world and are listed in coaching books and papers. The following is one that I like to use sometimes at the end of a practice session, or simply to replace what has been planned when I find that the players are physically and /or mentally fatigued. I have used this game with all levels of players.

The game is baseball, yes baseball played on a basketball court with a basketball. It uses the concepts of offence and defence and many basketball skills (running, change of direction, shooting, catching, passing, communication, vision etc). The game uses the general rules of baseball or you can add some variations of your own.

Having divided the players into two teams one is designated the fielding team. First base is on the sideline, halfway between the baseline and the centre line. Second base is at the mid-point of the centre line and third base is on the opposite sideline to first base. Home base is on the baseline immediately behind the basket. The catcher stands on the baseline until the ball hits the ring or misses the ring and the pitcher stands at the free-throw line. All other fielders spread out around the court.

The batting team stands in a corner and the batter stands in front of the ring ready to play. The pitcher has 6 free-throws before changing (all players must pitch in turn). If the free-throw is successful it is a strike (3 strikes and out). If the shot misses, the batter may hit the ball anywhere (with open hand or fist) and then must run to first base. If the batter does not hit the missed shot or the catcher can catch it before he hits it, it is a ball (4 balls and the batter walks to first base). There are no foul balls as in baseball, that is the batter may hit the ball behind the catcher (in which case he must run). If a fielder can catch the ball after it has been hit and before it touches the floor (off the wall is OK) then the batter is out. Three batters out and the innings is over and the other team gets to bat.

On a hit, runners are out if the person on the base to that he is running can catch the ball before he gets to the base (no tagging is necessary, double plays are encouraged). A player may steal a base during play and needs to be tagged to be out. No base stealing is allowed on a player getting out and the player trying to steal cannot be out (must return to the base he just left).

It's a lot of fun and yet can still be used to teach many aspects of basketball.

The basic concept of defence.

The basic concept of defence is simply: *stop the ball from getting closer to the scoring area or goal*. Since it is the ball that scores it's obvious that primarily it is the ball we must stop, not the players, but they are of secondary consideration.

Since any concept of defence must be designed to defeat a concept of offence it is logical that in defence we must try to stop the ball from getting into spaces closer to the goal to reduce the risk of scoring. In other words the more we can force the offence to try to score from further from the goal, the better our chances of limiting the offences score.

While in basketball we can use this concept all over the court, the greater effort must be made within the 3 point line closer to the basket. The main purpose of the defence is to force the ball out toward the sidelines or toward the centre line to reduce the chance of scoring. The use of the shot clock in basketball encourages aggressive defensive teams to intensify their efforts.

Obviously, defending the ball from penetrating toward the basket and defending players in open spaces nearer the basket is of prime importance. In basketball, as in most sports, the most dangerous player is the one with the ball (as he is the only one who can score) and the next most dangerous player is that who is closest to the basket and to the ball. All good team defences recognise the most dangerous players in order of importance and create their defensive intensity toward them accordingly.

In the previous section on the concept of offence I mentioned the THREE main steps to developing a basketball player, and these apply equally to the area of defence. Again the best defensive players are the BEST DECISION MAKERS. They know when to leave their offensive player to go to stop the ball, when to switch to a more dangerous player close to the basket, when and where to block out for a rebound and when to intercept a pass, all through great vision and awareness and excellent footwork.

In defence obviously all players play without the ball, and yet to be able to stop the ball EVERY defensive player must CONSTANTLY be adjusting with the movement of the ball and in the same direction as the movement of the ball (*move with the ball and in the same direction*), as well as adjusting with the movement of the offensive player (or players) for whom he is responsible. As with offence, defensive players must see the ball at all times but also be aware of the offensive players and the space around them. Seeing as much of the court as possible is a key ingredient to being a good defensive player.

In a basketball team there are usually only a few players who are the major scorers but EVERY player MUST be a GOOD defensive player. Along with the above skills the main requirement to be a GOOD defensive player is EFFORT.

How to teach the concept of defence through movement and awareness.

The skills of basketball comprise at least 75% footwork and the ball skills and team skills are really add-ons to correct footwork. Initially the coach should point out that in playing defence most movement is lateral (either to the side or backwards) and to protect space the player should use the width of their body, that is facing their opponent, not turned side on.

To move to the left a player should step with their left foot first and to move to the right step with their right foot first. This keeps the player on balance (as opposed to crossing their feet) and allows the player to gain distance with their first step. This footwork is covered in detail in the next chapter, but players should learn early this basic principle of movement.

Using the following steps for beginner players allows them to start to understand the concept of defence.

ONE ON ONE - WITHOUT THE BALL: divide the basketball court, or similar area, crossways into lanes about 3 meters in width and have the players stand in pairs, one on the sideline and the other facing about 2 metres inside the court. The offensive player on the sideline walks across the court, in a zigzag movement, within his lane and the defensive player who starts about 2 metres inside the court, facing his opponent, tries to stay between the offensive player and the other sideline by moving left and right and backwards. Change at the other side of the court and repeat.

ONE ON ONE - WITH THE BALL: repeat the above drill with the offensive player dribbling a basketball, using left hand to go left and right hand to go right, and now stress to the defensive player to move with the ball and to stay between the BALL and the sideline behind him. To do so the defensive player needs to concentrate on the BALL and not the offensive player. After the initial try the offensive player can start to run slowly while dribbling, causing the defensive player to have to move quicker. Do not allow the offensive player to beat the defensive player easily to the other side (which obviously they will be able to do at this stage), as this is a defensive drill to learn the concept of defence and principles of movement.

For players with little athletic coordination this task of moving sideways and backwards will be somewhat difficult, especially with the offence moving a little quicker, but after a few tries the player will start to grasp the concept, even if the movement skills are poor.

TWO ON TWO - WITH THE BALL: widen the above lanes to about 5 metres and now have two offensive and two defensive players use each lane. The two offensive players will move approximately level with each other and the two defensive players will stay about 2 steps in front of their opponent. The offensive player with the ball will make 3 dribbles and then pass the ball to his teammate who will then make 3 dribbles and pass back his to his teammate and so continue across the court. For the defence we now introduce two important terms - ON-BALL and OFF-BALL.

When a defensive player's man has the ball that defensive player is ON-BALL and when a defensive player's man has not got the ball he will be OFF-BALL. The player OFF-BALL will be 2 steps toward the ball away from his man and form a triangle so that he can see both his man and the ball. On EVERY pass both defensive players will move in the same direction as the ball and change from being ON-BALL to OFF-BALL and vice-versa. At this early stage it is important for the coach to stress that the defensive player moving to OFF-BALL does NOT follow the ball with his eyes but looks straight ahead to ALWAYS see BOTH his man and the ball, using peripheral vision. This basic principle of movement and vision is critical to being able to make good decisions about when and where to move.

The coach should point out that the reason the OFF-BALL player forms a triangle between the ball, his man and himself is to be in a position to be able to help stop the ball should the dribbler make a move in his direction and start to beat his teammate. In this way the defence is always in a position to STOP THE BALL, providing that ALWAYS the defensive players adjust with the ball on a pass to adopt their new responsibility of ON-BALL / OFF-BALL.

After this initial introduction for beginners, and for those who can already play a bit, the coach can now move onto the TWO on TWO and THREE ON THREE drills outlined under **How to teach the concept of offence through movement and awareness**

FOOTWORK OF OFFENCE AND DEFENCE

Running and stopping.

Basketball is a running game, not a hopping, skipping, dancing game and yet so many players when asked to perform a skill use one or more of these steps in their movement. Why? Because they have not been taught basic athletic movement. BASKETBALL SKILLS ARE 75% FOOTWORK and so all TEACHING AND CORRECTION by the coach should ALWAYS be FROM THE FEET UP.

Speed up and down the court is not a pre-requisite to being a good player, although it is very helpful. Basketball, due to the small area in which it is played, is a sport where A QUICK FIRST STEP (explosive movement) is much MORE IMPORTANT, be this an initial step or on a change of direction. Hence correct footwork is so important. Players need to learn not only what to do but why they should use these movements. It all seems so logical really.

Basketball is a game of straight lines and angles (changes of direction), not running in circles (the shortest distance between two points is a straight line).

Coaches need to understand some basic points of the biomechanics of body movement. The legs (and arms) are levers with a hinge joint at the knee (and the elbow) and so wherever the foot points, so does the knee and quick movement can only be in the direction of where the foot is pointing. Sounds simple and logical and yet many players are not aware of EXACTLY where their foot is pointed. A couple of centimetres off the angle will cause a step away from that straight line between the two points (where the player is to where wishes to go) and therefore lose the advantage of beating an opponent. So the first step to teach is POINT THE FOOT WHERE YOU WANT TO GO.

Secondly in movement all POWER COMES FROM THE LEGS and so players need to PLAY WITH THEIR KNEES FLEXED (in general terms the more flexion the greater power). In basketball the legs should only ever straighten when a player jumps to shoot, attempt to block or rebound. It also follows that where the FEET ARE POINTED so will be the MAXIMUM POWER available from the bent legs. Thirdly, THE HEAD CAUSES MOVEMENT OF THE BODY. To move forward our head must move forward first, to move backwards our head goes back and so it is to the side. This movement of the head is ONLY for the first two steps to create the explosive movement. Apart from this situation the player should keep their HEAD IN THE MIDDLE OF THEIR BODY for best balance and also keep the HEAD UP at all times (including on this initial explosive movement) to maintain good vision. On the initial movement the player must STEP OUT WITH A LONG STRIDE TO GAIN DISTANCE, to move explosively with their first step and beat their opponent.

Basketball coaches can learn a great deal from athletics coaches, especially the sprint coach. The 100-metre sprinter starts in the quickest method possible. Feet are spaced apart (wide base from which to power off), feet are pointed forward (where the athlete wants to move), knees are bent (for power), head is forward (to create the explosive movement), head is up for vision and remains in the centre of the body throughout the sprint (for best balance). Any movement of the head sideways (wobbling from side to side) and failure to point the feet in the straight line ahead, causes the athlete to move away from the shortest distance between the start and finish and therefore takes the athlete more time to cover the distance. The athlete is also taught to push hard with the legs and stride out with long steps for the first few metres to gain distance and to not stand upright quickly so that the power is forward where he wishes to go, not up.

While in basketball the player does not ever crouch as low as the sprinter, the same principles of movement allow the player to move explosively, both with and without the ball. Later in this chapter there are a series of drills, which will allow the player to practice learning these principles.

Obviously in a fast moving game on a small court area, such as basketball, also need to be able to stop quickly. If the head causes movement the same applies to stopping. The PRINCIPLES OF STOPPING are CREATE A WIDE BASE (feet apart, either in an open stance, ie parallel, or in a closed stance or stride stance, ie one in front of the other), LOWER THE CENTRE OF GRAVITY by bending the knees (the centre of gravity is in the hips), BRING THE HEAD BACK OVER THE BASE (feet) and have the HEAD UP for vision. Generally speaking, athletes with a higher centre of gravity (that is their hips are located higher in their body, in other words they have longer legs in proportion to their upper body) are more athletic than those whose centre of gravity is located lower in their body. This is one reason that certain races of people (example those of African descent) are more athletic than others (example those of European descent) and also the reason that males, generally, are more athletic than females (females usually have a lower centre of gravity and also have a different pelvic structure).

Pivoting.

This simple movement is incorporated in almost every basketball skill, both with and without the ball. PIVOTING IS simply a movement of CHANGING DIRECTION, either FORWARD OR REVERSE, keeping one foot in contact with the floor. The player maintains contact with the floor by the BALL OF THE PIVOT FOOT (that which is in contact with the floor and when the player is standing holding the ball so important in the travel rule) and uses a WIDE AND LOW STANCE to take small steps in any direction. The FEET need to stay APART so that the body can take up as much space as possible and the stance must be LOW FOR POWER (the upper body should be vertical and the head up for vision). The NON PIVOT FOOT should be MOVED CLOSE TO THE FLOOR, not in high steps which are slow, and also tend to make the player bring the non pivot foot closer to the pivot foot (a bit like a ballet pirouette) which causes the player to stand more upright and so lose power in the legs.

Many coaches say that PIVOTING and LATERAL MOVEMENT are the CORNERSTONES of basketball skills, as they are used in almost every skill in the game.

Change of direction.

If you thought that the preceding material on footwork was all logical then I hope that you find this section on changing direction to be the same, but for many coaches, and players, it will be a deviation from what has been taught, and used.

When babies start to walk they automatically step with their left foot to move left and their right foot to move right. As people get older a percentage of the population, including of course many basketball players, use the unnatural movement of changing direction by crossing their feet. The natural, and logical, way to change direction is to STEP WITH THE LEFT FOOT TO GO LEFT and STEP WITH THE RIGHT FOOT TO GO RIGHT. Crossing the feet places the player off balance and does not allow him to gain any distance. Since a player USES A CHANGE OF DIRECTION TO BEAT AN OPPONENT, maintaining BALANCE AND gaining DISTANCE ARE TWO REQUIRED ACTIONS.

As we learned back in the section on running, the maximum power is delivered in the direction where the feet are pointed and so in changing direction this movement becomes extremely important if the player is to beat his opponent with a quick explosive step. Another important action is that just before the player is to change direction he must slow down his speed a little and bend his knees more to gain extra power. UP IS SLOW, DOWN IS GO!

So in logical sequence TO CHANGE DIRECTION TO THE LEFT a player should SLOW DOWN a little, BENDS HIS KNEES more, PLANT his RIGHT FOOT FORWARD, make a slight PIVOT ON the ball of his RIGHT FOOT and STEP OUT EXPLOSIVELY WITH LEFT FOOT in the new direction. The opposite footwork is used to change direction to the right. Now the player should slow down, bends his knees, plant his left foot forward, make a slight pivot on the ball of his left foot and step out explosively with his right foot in the new direction.

Some players do step with their correct foot to change direction but fail to pivot on their front foot and so their power is not all directed at the new direction they wish to move, consequently they are not as explosive as they could be. And other players using the correct foot tend to move in a circle to change direction and so are even slower. The angle of a change of direction must be sharp to beat the opponent with the first step.

For players who are not used to using their feet correctly to change direction this action will initially feel awkward, especially with a change of direction with a dribble, but perseverance will allow them to become more explosive.

Of course the question of changing players must be addressed by the coach and is dependent on the age of the player. Older players (those well into their 20's) are often so set in their habits and feel so comfortable with them, even though they may be incorrect, that to change their skills would do more harm than good. But it is not always impossible at such an age for a player to change some of his habits, but if the coach decides against changing the player's footwork, there is always the vision and decision making which may require developing. Younger (or newer) players usually have less bad habits and so it is easier for them to re-learn good habits.

In DEFENCE a player also uses a change of direction when moving sideways or backwards and the same principles are used. The player pivots on the leading foot and steps with the other foot in the new direction (often called a drop-step). There is no difference to the action, except that it is executed while moving backwards.

Most players find this easy to do and when shown that in forward movement it is exactly the same principle, usually quickly understand. Coaches do not have to teach two separate skills, just the one principle. KEEP IT SIMPLE!

Lateral movement.

LATERAL MOVEMENT IS the movement USED by basketball players MOST OF THE TIME, both IN OFFENCE AND DEFENCE. It is the action of running with the feet pointed in the direction of movement and the body turned at an angle to face the inside of the court for best vision. A player moving toward the sideline should always make an inside turn (ie change of direction), either forward or reverse, to face the middle of the court. A player who turns outwards toward the sideline loses all vision of the court and therefore the other players (hence decision making is temporarily poor).

The racquet sports (tennis, table tennis, badminton and squash) use a lot of lateral movement and are excellent for basketball players to play in the off-season. These sports also teach the players to step right to go right and step left to go left.

Shuffling.

Mostly referred to by coaches as a defensive movement, but shuffling is also used on offence, mostly with the ball as in a control dribble, a hesitation dribble or faked crossover dribble. Shuffling is the action of taking short steps with the foot lifting from the floor by only a couple of centimetres and for the shortest possible time.

In DEFENCE this action is used to move sideways and backwards, firstly by taking a big step in the direction the player wishes to go (this happens on every change of direction) to gain distance and then taking short quick steps as described above. In ON-BALL DEFENCE the player never moves directly backwards which would only allow the offensive player to get closer to the basket, but must MOVE BACKWARDS AND ACROSS THE COURT at the same time (more like a crab moves), which allows the defensive player to use the width of his body to protect the space from the ball penetrating past him and also allows for correct change of direction to prevent penetration of the ball on a change of direction by the dribbler.

When playing ON-BALL DEFENCE within the 3 point arc the player is ALWAYS SHUFFLING, sideways and backwards, TOWARD THE SIDELINE and so THE LEADING FOOT MUST always BE POINTED DIRECTLY AT THE SIDELINE, to enable the player's hips to be pointed from sideline to sideline and so have the body as square across the court as possible, to take up space laterally. The quick sideways step is used primarily to take away the drive toward the basket. Outside the 3 point arc and when the player has to take more than 3 shuffling steps, he will need to run laterally to make position (see the section of team defence).

Coaches should teach that this leading foot must be exactly at right angles to the sideline as even a couple of centimetres back or forward will change the angle of body movement and allow an opening of the space toward the basket or maybe cause a blocking foul (as in moving forward). I repeat again that players need to be AWARE of WHERE THEIR FOOT IS POINTED.

As the coach can see the teaching points for all footwork start with the basis of running and stopping and build in a logical manner, using the same principles. We do not need to teach separate movements, simply add on to those of running and stopping. KEEP IT SIMPLE!

Footwork drills.

For all teaching and correction for the following drills refer to the notes on each movement earlier in this chapter. REPETITION AND CORRECTION are the KEYS TO IMPROVEMENT. Players who are allowed to PRACTICE INCORRECTLY will DEVELOP INCORRECT HABITS. Have all players warm up and stretch prior to commencing drills and then have them build from comfortable speed to MAXIMUM WORK RATE. After the player is reasonably comfortable with the movement have them PRACTICE THE WAY THEY PLAY, that is fast (alternate this from 75% to 100% speed). This will help eliminate mistakes at practice and help the players execute better in a game.

Let the players know that making MISTAKES IS NORMAL and acceptable and is an important part of development. Players who are not making mistakes are probably not challenging themselves to do it quicker. Provided that the player is AWARE, or made aware, OF THE MISTAKE and tries to CORRECT IT, or part of it, each time then IMPROVEMENT WILL OCCUR.

Each of these drills should be done on a full basketball court (or similar area) but for groups larger than 20 the coach may choose to work across the court to accommodate more players each time.

Running to a jump stop and pivot drill.

Have the players stand on the end line of the court (depending on numbers you may need to divided the team into two groups with one group running at a time) and on the command READY have the players adopt a parallel stance with feet shoulder width and knees bent, head up. On the command GO the players THROW their HEAD FORWARD (keeping it up for vision), TAKE A LONG STRIDE FORWARD with their right foot and PUSH HARD with their legs TO EXPLODE away. Have them STAY LOW for the FIRST TWO STRIDES.

At various distances down the court (start with distances of about 7 metres, ie free throw line, centre line and other free throw line, and then vary the distances) the coach uses a whistle to have the players come to a jump stop (short jump forward with feet close to the floor, landing on both feet simultaneously, feet wide apart, knees bent low, hands at waist, head back over feet and head up). Have the players STAY DOWN LOW and on the command GO the players repeat the procedure to move explosively, still stepping first with the right foot. The coach can vary the time the go command is given again each time, from immediately to a couple of seconds.

At the other end line this group waits, if necessary for the other group to perform the drill, and then goes back down the court with the same drill, this time stepping first with the left foot.

POINTS that the coach should look for TO CORRECT are: on GO some players will take a short step backwards before stepping forward, obviously making them slow to move; some players will not stay down low and will start to stand up causing them to have to bend again to move, obviously making them slow; some players will take too high and long a jump to stop, obviously making them slow; some players will not sprint at full pace trying to anticipate the whistle, in which case the coach should delay the whistle, sometimes even until they reach the other end line, and stress full pace until the whistle is heard.

An addition to this drill should be to have the players MAKE A forward or reverse PIVOT on coming to a jump stop to FACE THE OPPOSITE DIRECTION before moving on GO. This is a SIMPLE but EXCELLENT DRILL to teach players TO MOVE EXPLOSIVELY, STOP AND SQUARE UP QUICKLY.

Running to a stride stop and pivot drill.

Use the above drill but this time the players come to a stride stop, landing on one foot and then the other foot, a stride ahead. STRESS THE same PRINCIPLES OF STOPPING QUICKLY. In one direction the players land first on their right foot and then on their left and in the other direction down the court land first on their left foot followed by their right foot.

As soon as the front foot lands on the floor the player should SQUARE UP, that is bring the front foot back to be parallel with the rear foot and STAY LOW and be ready TO EXPLODE again ON the command GO. The player must ALWAYS STEP FORWARD WITH THE NON PIVOT FOOT, that is the one that was the front foot. In this way the player will LEARN TO NOT TRAVEL when he has the ball.

Just as in the running to a jump stop and pivot drill the addition of a PIVOT TO FACE THE OPPOSITE DIRECTION, both forward and reverse, should be added, always USING THE CORRECT FOOT to pivot on.

POINTS that the coach should look TO CORRECT are the same as for the preceding running to a jump stop and pivot drill plus correct use of the pivot foot.

Change of direction full court lane drill.

Have a maximum of 5 players stand on the end line, evenly spaced and with the outside players well inside the sideline. In one direction down the court the players should start by moving to their right and in the other direction start by moving to their left. Ensure that the players USE the CORRECT TECHNIQUE TO MOVE EXPLOSIVELY. On the command GO the players sprint away and on the whistle make a change of direction. On the CHANGE OF DIRECTION stress SLOW DOWN a little, GET LOW by bending the knees more, PLANT the RIGHT FOOT FORWARD and make a slight PIVOT on it and STEP OUT WITH THE LEFT FOOT pointed in the direction the player wishes to move. THROW the HEAD FORWARD and PUSH WITH the LEGS TO EXPLODE away. To change to the right the opposite footwork is used. The coach should vary the distances between changes of direction.

POINTS that the coach should look TO CORRECT are: standing too upright before the change of direction; not pivoting on the planted foot; using the wrong foot to step in the new direction; taking a short stride

instead of a long stride to gain distance on the change of direction; standing up too soon instead of staying low to explode away; head facing down instead of up for best vision and decision making.

Lateral movement with inside turns drill.

This drill teaches players lateral movement and when moving toward the sideline to always change direction to face the court and the direction they are moving. Some coaches allow this drill with a reverse pivot to change direction, however this causes the player to be off balance and to lose vision on the court in the direction, which they are moving. This could be compared to a reverse dribble versus a behind the back dribble. The latter change of direction allows the dribbler to maintain vision in a forward direction.

The coach places cones, or articles, about 5 - 7 metres apart down each sideline with those on one side staggered with those on the other (to allow the players to run at angles across the court).

The players all line up on the end line in one corner and on the command GO run (each about 2 metres behind the player in front) with lateral movement toward the cone on the opposite sideline (that is the players feet are pointing in the direction he is running and his upper body and head is turned to face down the court and hands are held up around the waist area). The players use peripheral vision to see the player in front and the cone and on arriving near the sideline the players make a change of direction using the correct footwork and continue crossing the court to each cone until they arrive at the other end line.

A variation of this drill is to have the coach move backwards and ahead of the players down the court, holding up different numbers of fingers as he moves and the players have to be able to call out the correct number of fingers being held up. This adds to development of peripheral vision and makes the players face the court correctly.

Another variation of this drill is to have the cones placed opposite each other down the sideline and split the team into two groups. One group starts at the same time as the other from opposite sides of the same end line. Now the two lines will cross each other and this helps develop communication between players and also develops peripheral vision (the coach can still use the counting fingers routine, which places more decision making on the players).

POINTS that the coach should look TO CORRECT are: running sideways and crossing feet instead of feet being pointed ahead in the direction of movement; upper body and head facing the same direction as the feet; poor use of peripheral vision to judge the distance and position of other players on the court and the position of the cones; incorrect technique on change of direction; hands drop below waist.

Mass defence drill.

This very common and worldwide drill teaches correct footwork for shuffling for both offence and defence and includes changes of direction.

The players from up near the centre line in lines of 5 spaced across the court facing the coach. Each line is about 2 metres behind the one in front. The coach has the players adopt a low stance with feet about shoulder width apart. By pointing his hand to the sideline, back and across the court, forward and across the court and forward the coach has the players shuffle in those directions (vary the number of steps, up to a maximum of 5, before changing the direction). The drill is performed at maximum work rate for a maximum of 10 seconds (preferably 5 -6 seconds). The reason for this amount of time is that when playing intensive defence ON-BALL the player will usually only have to play for 5 -6 seconds before the dribbler will pick up his dribble or pass or shoot. Drilling for 10 seconds allows for an overload system without employing fatigue. With a rest of 20 seconds in between the drill should be repeated 3 times. This drill used in the early part of every team practice session will improve footwork and set the tone for short, sharp, intensive work during the practice session.

POINTS that the coach should look TO CORRECT are: head bobbing up and down, meaning that the player's feet are coming too close together on each step, or change of direction and therefore his legs are straightening, causing him to be slow in moving; taking a short step on a change of direction, when the player needs to step out to gain distance on the first step followed by short, quick steps thereafter; body turned sideways (that is in a line between the corners of the court) due to the rear foot being too far behind the level of the front foot or the leading foot not being pointed at the sideline when going sideways and backwards, which places the hips pointing across the court and gives width to the body; stepping with the incorrect foot to move sideways, backwards or forwards, it must always be the foot in the direction the player wishes to move (ie use the right foot to go right, the left foot to go left).

Open and closed stance shuffling drill.

This is another simple but excellent drill for teaching quick, explosive footwork of closed and open stances in defence.

The players line up down the court (more than one line may be required) about 2 metres behind the player in front and all facing the coach. By pointing direction right or left on the command of GO the players move forward 3 steps in a closed stance, then immediately move backward 3 steps in the same stance and then open up off their leading foot (ie their back foot) to take 3 steps in an open stance across the court.

As a variation to this drill the coach may point left or right before the 3rd step backward in the closed stance to vary the direction the players must move. In this way the coach is simulating opening to a pass or recovering to the player's man.

POINTS that the coach should look TO CORRECT are: heads bobbing up and down meaning that the player's feet are coming too close together and or his legs are straightening; short steps on a change of direction and therefore not gaining distance; body turned sideways (ie hips pointing from corner to corner) in the open stance meaning that the players leading foot is not pointed at the sideline and therefore his hips are not square across the court.

BALL SKILLS FOR BASKETBALL

Ball handling.

All players love to handle the ball, particularly dribbling and shooting and the main skill that helps a player develop into a great dribbler, passer and shooter is ball handling drills. Without practising these drills frequently (preferably daily) a player will not master these three skills of the game, regardless of how much dribbling, passing or shooting he may do.

The key to ALL BALL CONTROL is the USE OF the FINGERS AND THUMB on both the RIGHT AND LEFT HAND. In dribbling, passing and shooting THE BALL SHOULD FIT THE FULL LENGTH OF THE FINGERS AND THUMB and these should be SPREAD WIDE APART and GRIP THE BALL when in contact. The best way to learn how to handle the ball is to turn one hand face up and spread the fingers and thumb as wide apart as possible and then place the ball in the hand. The player will notice that the ball fits in the fingers with THE PALM AND BUTT (bottom) of the hand OFF THE BALL. In addition the SIDE of the THUMB fits the ball. Some players grip the ball too hard, causing the ball to move up onto the pads of the fingers and more especially the pad of the thumb. This reduces the control of the ball.

Ideally some ball handling drills should be done every day but at least three days a week. The following list of drills range from quite simple to more complicated. For the best results the each drill should be performed for a set time so that a score can be recorded and this score challenged to be improved each time it is performed. For players under 14 years of age 20 seconds is the recommended time for each drill and for players older than this age the recommended time is 30 seconds.

Each drill should be performed at a fast speed. As the player reduces the number of mistakes the speed should be increased to maximum speed. Through this the player will develop both confidence and competence in their ball handling. Doing some ball handling drills before any dribbling, passing or shooting practice is also a good idea.

For those coaches who are fortunate to obtain a copy of the video showing Pete Maravich and his ball handling skills from the 1960's their players will be amazed at the speed and control he possessed. At around 6 foot in height he was short to play in the NBA but his ball handling was superb and helped him to play at the highest level of the game.

The score sheet will help the player to be able to keep score and use this score to improve upon. Competition between players at practice is often a good motivator to practice these drills at home.

BALL HANDLING RESULTS SHEET

PLAYERS NAME: _____

COMMENCE ALL BY BALL SLAPS EACH DRILL TO BE DONE FOR 30 SECONDS. ALL DRILLS AT MAXIMUM SPEED TO DEVELOP COMPETENCE AND CONFIDENCE.

BALL DRILL	D A T E									
	S C O R E									
overhead turning/tapping	NO		S	C	O	R	E			
head wraps										
waist wraps										
leg wraps										
head/waist/leg wraps										
figure 8 wraps										
alternate leg wraps										
ricochets										
drop and catch										
figure 8 dribble										
reflex scissors										
spider dribble										
scissors dribble										

Coaches will find it much easier to teach all of the following ball skills for two reasons. Firstly the players love to handle the ball, it is their focus (incorrectly so) in the game and anything which involves the ball is fun to them. Secondly the skills themselves are so simple to learn, provided the coach teaches and corrects the above points on ball handling. In addition the footwork associated with the following drills are exactly those which are taught for all movement, as outlined in the previous chapter. As the player becomes more confident and competent in the footwork and ball skills then the player can concentrate more of the MORE IMPORTANT SKILLS OF READING THE GAME AND DECISION MAKING.

Catching.

There are THREE WAYS TO CATCH THE BALL, firstly WITH THE FEET, secondly WITH THE EYES AND thirdly WITH THE FINGERS. In other words the players must move toward the ball as it is in the air, look at the ball into his hands and catch the ball, with arms bent, by letting it hit his thumbs and then closing his fingers around the ball. The players FINGERS AND THUMBS must be SPREAD WIDE (normal ball handling skill) and when the FINGERS CLOSE AROUND THE BALL they GRIP THE BALL. The player should RECEIVE THE BALL WITH A HAND ON EACH SIDE and from lots of ball handling drills he will know where the ball is in his hands and be able to pass, dribble or shoot without looking at the ball or adjusting it in by having to slide it around in his hands (do not let players “fiddle” with the ball in their hands – catch it and grip it!). Players who need to adjust the grip or position of their hands on the ball after catching it are slow in making the next movement (although this is necessary to shoot the ball and to make some types of passes).

The reason for receiving the ball WITH the ARMS BENT is so that the PLAYER HAS IMMEDIATE POWER in his arms (just as bent/flexed legs provide power). IF THE PLAYER REACHES for the ball with his hands and catches the ball with his arms straight HE FACES TWO PROBLEMS. Firstly the ball tends to hit the butt of the hands and bounces out a little and the player has to make a second effort to grip the ball (it often makes a double sounding noise) and secondly the player has to bend his arms before passing, dribbling or shooting, therefore making him slow to perform the next movement. The footwork of A JUMP STOP ALLOWS movement off either foot and is quick FOR A DRIVE OR PASS IN EITHER DIRECTION or quick catch and shoot action (by squaring to the basket while in the air before landing in the jump stop). A STRIDE STOP IS a QUICK way TO MOVE STRAIGHT INTO A SHOOTING ACTION.

Having caught the ball the player needs to be ready to pass again, dribble or shoot and we call this position - THE TRIPLE THREAT POSITION. This simply means that when the player catches the ball he TURNS TO FACE THE BASKET - called SQUARING UP and be ready to perform one of these three skills.

When moving away from the basket to catch the ball the player should either make a reverse pivot on the outside foot (that closest to the sideline) or a forward pivot on the inside foot (that closest to the split line - the imaginary line down the middle of the court between the two baskets). In this way the player will always see the court and importantly the player who just passed him the ball (ready to make a pass and cut/give and go play) and all other players who may be open for a quick pass, as well as his defender for a quick step and drive to the basket.

Players who make a forward pivot on their outside foot or a reverse pivot on their inside foot will only see the sideline of the court and take some valuable time before having vision on the whole court, the basket and the balance of the players. Such moves have no benefit in the game for the player except to be able to wave to friends and family and let them know what a “great game” he is playing.

When a player receives the ball moving toward the basket the footwork for SQUARING UP is the same, but the preference is usually to make a forward pivot on the inside foot, which allows a player to move into a shooting action much quicker.

Whether moving away from or toward the basket the player should have some vision on his defender and the position of the defender will help him determine which type of pivot to use to be able to square up to an open space away from the defender. For example, on a move away from the basket where the defender attempts to pressure, or intercept, the ball a reverse pivot on the outside foot enable the player to square to the basket with an open drive toward the basket on the baseline side.

When the player SQUARES UP he should always do so WITH his KNEES FLEXED (bent low) for immediate power, HEAD UP WITH VISION TOWARD THE RING AND BACK FAIRLY STRAIGHT and must take the ball to his hip on the side of his free foot (non pivot foot side) when moving away from the basket as the choices are usually to dribble, pass or shoot in that order. When the ball is at the right hip the right hand should be behind the ball and the left hand on the side of the ball (this requires a slight rotation of the wrists as the move to SQUARE UP is made). Obviously the hands are in opposite position when the ball is at the left hip. When moving

toward the basket the ball should be taken to the shoulder on the free foot side as the choices here are usually in the order of shoot, pass and then dribble. Now the hands should be positioned so that the natural shooting is underneath (allowing for a quick release on the shot). There are FOUR TRIPLE THREAT POSITIONS - one on either hip and one on either shoulder. Players should LEARN to use ALL FOUR TO BE A GREATER THREAT on receiving the ball.

Passing.

Passing is the QUICKEST WAY TO MOVE THE BASKETBALL but is the least liked by many players, especially those just learning the game. Most players would rather dribble or shoot the ball than give it up but eventually they learn that by passing the ball to others when they are open then teammates will pass the ball to them when they are open. Basketball is a game played on both sides of the body and so players need to learn how to pass (as well as dribble and shoot) with each hand. A player who can ONLY USE ONE HAND IS ONLY HALF A BASKETBALL PLAYER.

Since the shortest distance between two points is a straight line, most PASSES SHOULD BE as STRAIGHT as possible, which is NOT WITH AN ARC (loop) in them. A pass with AN ARC IS SLOWER through the air and allows the defence an opportunity to intercept the ball. There are some exceptions such as a bounce pass, a skip pass, a lob pass and an alley-oop pass.

GOOD PASSING RELIES only partly ON GOOD TECHNIQUE and more so on GOOD VISION AND AWARENESS of where players are in open spaces. This is why at lower standards, where players are not well spaced apart and moving to open spaces, there are many more turnovers from poor passes, even though the technique of the pass may be correct. In addition correct skills in catching can make a poorly executed pass be successful.

Because basketball is a movement game it is important that player be taught to PASS AND MOVE to a new position (not pass and stand still) and always expect a return pass, therefore MAINTAINING VISION ON THE BALL is most important (a player should never pass and turn his back to the ball). From the beginning all drills should include PASSING AND MOVEMENT AND VISION on the ball AS WELL AS USING EACH HAND.

The basic concept of offence in TAKING THE BALL TO AN OPEN SPACE APPLIES not only to passing the ball to a player away from their defensive player but also TO MAKING A PASS BY A DEFENDER. This means that the player making the pass must read his defender and if the defence's hands are up then the pass is made low and if the defender's hands are down then the pass can be made higher. Finding the space by this defender is equally as important as finding the open space where the teammate is. A simple rule to teach players is to FAKE A PASS TO MAKE A PASS, that is to fake up with the ball (always maintaining knees flexed) and pass low as the defender's hands react to the fake and vice-versa on a downward fake. In order to make an adjustment with the ball A PLAYER MUST ALWAYS HANDLE THE BALL WITH BOTH HANDS and grip it. Players who handle the ball in one hand before the point of release are prone to making poor passes by "telegraphing" the pass to the defender and not being able to make any adjustment at the last possible moment.

In teaching vision and decision making the coach must teach players to BE AWARE OF THE PASSING LANE AND THE PASSING ANGLE. The passing lane is the line between the ball and the receiver and occupies an area of about a metre on each side of this direct line. The passing angle is the angle between the two lines connecting the ball and the receiver and the ball and the closest defender to the receiver (the passer needs to observe both his own defender and the closest defender to the receiver). The wider the passing angle then the safer is the pass (ie if the receiver is in an open space and yet in tandem with the ball and the ball handler's defence then there is no passing angle and the passer is forced to make a pass over the top of his defender, creating an arc with the flight of the ball and allowing the defence an opportunity to intercept the ball). In playing 2 on 2 games in the early stages of teaching sports the player not only learns to move to spaces away from the defence but also how to read the defence and create good passing angles for the ball handler.

As with all skills in basketball correct FOOTWORK IS THE KEY and so it is with passing. The POWER for the pass comes mostly FROM THE LEGS with the arms, wrists and fingers/thumbs providing the sharp impetus to the ball. The direction in which the feet are pointed is that where the maximum power will be directed and so POINTING THE FEET TOWARD THE RECEIVER IS IMPORTANT. ALL PASSES, like dribbles and shots, ARE A PUSH. The basketball is ALWAYS PUSHED, even though we talk of throwing a pass. A throw is made from behind the level of the ear (ie past the head) and with the elbow pointed away from the body causing a sideways action with the arm. In basketball all passes are made from in front of the ear (ie NEVER from BEHIND THE EAR) and a pass, like a shot, is made by extending the arm/s (the lever action) rather than the whippy, sideways action of throwing.

Another important lesson to be learned by players is to protect the basketball at all times. If they have learned the basic concept of offence well then this will be a simple reminder to take the ball away from the defence to an open space, that is when holding the ball move it to the opposite side of the body to the defensive player and if necessary use a pivot to keep some part of the body between the ball and the defence. A good teaching rule is - BALL - BODY - MAN (always part of the body between the ball and the defence).

There are several types of passes in basketball and each has a specific use in the game. The following are the types of passes and the techniques for teaching correct execution. IT IS IMPORTANT that coaches start TO TEACH players BALL HANDLING and how TO CATCH CORRECTLY before starting to teach passing and to USE RIGHT AND LEFT HAND.

THE ONE HANDED PUSH PASS - is the QUICKEST PASS in basketball, either from a standing position or off the dribble, and is mainly USED AROUND THE PERIMETER OF THE OFFENCE (outside the lane). Because most beginner players find it easier to pass with one hand initially THIS IS THE EASIEST PASS TO TEACH FIRST and also the more effective, especially later at higher levels of play. Players should learn to make this pass with the right hand and the left hand. The position of the hands on the ball is similar to that for shooting the ball, one hand (the passing hand) is behind the ball and the other (the guiding hand) on the side of the ball, always ensuring correct ball handling and grip (this must be stressed in all passes).

The ball is held in both hands at chest height on the side of the passing hand and the arm is straightened quickly as the foot on that side of the body steps out in the direction of the pass (the foot should be pointed at the receiver to ensure maximum power for the pass - POWER FOR THE PASS COMES MAINLY FROM THE LEGS, as in shooting - refer to teaching body movement in Chapter 1) and the ball is released from the fingers of the passing hand with a downward action of the hand (breaking the wrist action). The guiding hand fingers straighten just before release to assist in accuracy of the pass. On the release, the fingers of the passing hand must still be spread wide apart and the wrist must be level and pointed at the receiver. The passing action should be snappy and the passing arm should move directly out at shoulder height (similar to a straight jab in boxing). Any action of sideway movement with the wrist places a sidespin on the ball causing problems in catching.

IN ALL PASSES AND SHOTS THE BALL, after release, MUST SPIN BACKWARDS which keeps it in a straight line in the air and helps it to stop when it hits its target. All cricket and baseball fans would know that by spinning the ball sideways though the air it curves, therefore slowing it a little and causing it to glance off its target at an angle. That is NOT what we want in basketball and so sideway spin is not desirable and is only caused by incorrect technique on release.

THE TWO-HANDED CHEST PASS - this is often the first pass taught to beginners because, supposedly, two arms are stronger than one for small children. However children usually find the technique a little difficult to learn, especially the positioning of "little hands" on each side of the ball. The Chest Pass is USED AROUND THE PERIMETER of the offence and FOR MEDIUM DISTANCE passes (for senior players this means across the width of the court). Like the One Handed Pass, the Chest Pass is both quick and accurate.

The players position a hand on each side of the ball (players should learn that THE BALL HAS A TOP, A BOTTOM, A FRONT, A BACK AND TWO SIDES - like a cube), fingers and thumbs spread wide and pointed toward the receiver, arms bent and the ball sitting just in front of the player's chest. To release the ball the player steps forward with the non-pivot foot in the direction of the receiver and straightens the arms, both at the same time, and releases the ball with a downward breaking of the wrist at the same time rotating the thumbs down and out to create the backspin on the ball. In order that the ball shall travel in a straight line to the chest of the receiver the arms, on release of the ball, should be pointed at the receiver. Common problems in execution are the arms pointing down toward the floor on release causing the ball to travel downwards to the receiver (ie the receiver has to catch the ball low and therefore is not in a position to make a quick pass, dribble or shot); the hands are not placed equally on each side of the ball (one is more behind the ball than the other) and this causes the ball to be passed with one hand more than the other and makes the ball go away from the straight line to the receiver (ie a right hand dominant pass pushes the ball to the left of the target and vice-versa with the left hand)

Again the FOOTWORK IS ALL-IMPORTANT and includes wide stance, feet pointed at the receiver and knees flexed for maximum power. In addition the HEAD must be UP FOR GOOD BALANCE AND VISION.

THE BOUNCE PASS - may be executed with either a one handed or two handed pass and is used to pass the ball by a defender who may be able to get a hand into the passing lane. It is only used over short distance because of its slow action. Whilst this type of pass is sometimes used on the perimeter (because the pass is slower

than a direct pass due to the ball having to go down to the floor and then up again to the receiver) it is not recommended as a perimeter pass where quickness is desirable and it is more USED TO PASS THE BALL INSIDE to a player in the lane. Many coaches teach (incorrectly) their players in defence inside the lane (especially in zone defences) to play with their hands up and so a bounce pass is an effective means of getting the ball to a teammate inside. It is also used to get the ball past a close defender on the ball handler and here again footwork is all-important, especially the skill of using a pivot to step around the defender to create a passing angle. In making the pass the same execution of the arm/s is used and the target for the pass should be a point on the floor about two-thirds the distance between the passer and the receiver, causing the ball to come to the receiver about waist height. Players find it difficult to have to move forward and reach down at the same time and so this pass is very effective in getting the ball by a defender close to the passing lane.

THE OVERHEAD (SKIP) PASS - this pass is USED TO REVERSE THE BALL from one side of the court to the other over the top of the lane and the defence. As we shall learn later the use of ball reversal is a very effective means of beating the defence, however the pass requires more strength in the arms due to their whipping action and also having to hold the ball overhead so it is advisable to only teach this pass when the players have some body size and strength in their arms (ie IT SHOULD NOT BE TAUGHT TO YOUNG CHILDREN). For young children and beginners the above three passes - One Handed Pass, Chest Pass and Bounce Pass should be taught initially.

Because this pass uses an arc in its execution (and is therefore slower through the air) it requires the passer to make good decisions about the position of the defence and their teammate in an open space. To execute a Skip Pass the ball is held with a hand on each side of the ball, above the head and in front of the face (if the ball is held above and behind the head the ball with travel downwards on release), the arms are slightly bent and to release the ball the arms are moved forward and straightened at the same time. When the arms straighten the ball is released from the fingers and thumbs in the same action as for a Chest Pass, that is the wrist is broken and the thumbs rotate down and out. After release the hands should be above head height, well out in front of the face and pointing toward the receiver. The action should be snappy so as to not create too much of an upward loop in the pass.

THE BASEBALL PASS - is USED TO MAKE A LONG PASS DOWNCOURT, usually on a fast break, and requires both distance and accuracy. Similar to the Skip Pass this pass requires arm strength and body size and is not recommended for young children and beginners. Players, at all ages and levels, must understand their passing range (like in shooting range) as trying to pass out of range leads to poor execution and accuracy.

The ball is held as for the One Handed Pass, that is one hand (the passing hand) is behind the ball and the other (the guiding hand) on the side of the ball, and the ball is held alongside the ear on the side of the passing hand (holding the ball behind the level of the ear causes the player to drop the guiding hand and therefore move the elbow away from the body causing the ball to come out of the side of the passing hand). Because of the longer distance of this pass compared to the One Handed Pass it is the FOOT OPPOSITE the passing hand which is MOVED FORWARD TO CREATE A WIDER BASE FOR BALANCE AND POWER. The guiding hand is released earlier than in the One Handed Pass, about halfway through the straightening of the passing arm, but the passing hand action is the same - break the wrist, wrist level with the floor. Since this pass requires more power it is usual for the player to take a longer stride with the non-pivot (power) foot and continue forward, by lifting the pivot foot before release and so it is important that the coach instructs players as to the travel rule for ball release on a pass (that is the pivot foot may be lifted but the ball must be released from the hand/s before the pivot foot regains contact with the floor).

Common mistakes in execution are that the player may remove the guiding hand too early from the ball and this usually causes the player's passing hand to move outwards, away from the side of their head and causes a more sideways action on release (the arm should straighten toward the target but instead straightens more in an outwards motion) which in turn diminishes the power (distance) and accuracy.

THE CURL (POST) PASS - is USED specifically TO FEED the BALL TO the LOW POST player, and sometime to the high post. It is in reality a bounce pass over a short distance and designed to get by close defence. There is a similarity to the One Handed Pass in that the hands on the ball are the same, the player steps with the same movement, that is using the foot on the side of the passing hand but the hand position on release is slightly different. This pass is meant to be made low, into the space away from the post defence. Many players try to feed the low post with a high pass and this only allows the post defence to get a hand on the ball (the post defence has his hands high and if the low post player has successfully pinned the defence (see later section on post offence) then he will be low and wide and needs to receive the ball around knee height.

As mentioned the execution is similar to that of the One Handed Pass but the release is slightly different in that instead of the wrist being pointed up it is level to the floor and so the spin on the ball is sideways which causes it to break back to the receiver after moving in a slight curve.

In the game of basketball players are faced with four possible passing situations and coaches should ensure that each situation is practiced in drills. The four passing situations are - standing to standing (hopefully seldom except in feeding the post player); standing to moving; moving to standing; and moving to moving. The term standing here refers mostly to slow movement and the term movement refers to explosive and quick movement. In addition another dimension exists in the game - that of distance and so drills should also reflect varying distances.

PASSING IS an integral part of the game of basketball and MAJOR SOURCE OF TURNOVERS in the game so it is imperative that coaches should teach and correct good execution as well as good vision and awareness and good catching. Good passing can increase the tempo of the game, defeat pressing defences and finds an open player much quicker than will a dribble and everyone in the team can participate in handling the ball, which makes him or her feel good as a contributor.

Dribbling.

This skill, along with shooting, is the fun part of basketball for most players and we see many young players copying their NBA idols with all types of fancy ball work but so often they have not been taught that there are ONLY TWO REASONS TO DRIBBLE the ball. Firstly it is used TO PENETRATE THE BALL (toward the basket) and secondly TO CREATE A BETTER PASSING ANGLE. That is not to say that all the “moves” that a player might learn are not of benefit in the game, of course they are, provided that the player has A PURPOSE FOR USING THE DRIBBLE, and it should be one of these two reasons.

In any group of beginners the first thing which a player will do when asked to pick up a basketball is to bounce it. This is one of the worst habits a player may develop and coaches should teach players to hold the ball correctly (squeeze it is a good teaching point) when they receive it rather than bounce so that in a game the player will not immediately bounce the ball upon receiving it and therefore waste his dribble. Coaches should teach players the two purposes for the dribble and then teach them - DO NOT PICK UP THE DRIBBLE UNTIL READY TO DO SOMETHING WITH THE BALL. Through this teaching a player will learn to use his dribble for a purpose, not to bounce the ball for the sake of bouncing it.

The execution of the dribbling technique is quite simple - it is the action of PUSHING THE BALL TO THE FLOOR by USING the extended FINGERS AND THUMB which grip (wrap around the ball on contact) AND by MOVING the WRIST AND the ELBOW UP AND THEN DOWN. As described earlier in the section on ball handling the fingers and thumb always fit the basketball the same way, regardless of whether it is a dribble, pass or shot. On a dribble the fingers and thumb actually come in contact with the ball on its way up and so move upwards slightly with this action before pushing the ball to the floor again. Beginners often make their first action to push the ball to the floor as soon as the ball is in contact with the fingers and so they get a jerky, slapping action rather than the smooth and controlled action of a well executed dribble. REMEMBER THAT THE BALL IS ALWAYS PUSHED.

There are TWO BASIC TYPES of dribble, a CONTROL DRIBBLE (sometimes called a protection dribble) AND a SPEED DRIBBLE. The control dribble is used to take the ball into open spaces between defenders (penetrate the defence) and the speed dribble is used to move the ball quickly down the court toward the basket in which the team scores (such as in a fast break). The ACTION OF A SPEED DRIBBLE is to PUSH THE BALL OUT IN FRONT (and to the outside) of the foot on the same side as the hand being used to dribble and the ball bounces ABOUT WAIST HIGH with the dribbler. The ACTION FOR A CONTROL DRIBBLE IS SIMILAR BUT the ball is DRIBBLED MUCH LOWER (between the knee and waist). The REASON FOR DRIBBLING is just like passing - to TAKE THE BALL SOMEWHERE and so there are seldom times in a game where the dribbler SHOULD stand still and dribble the ball up and down on the spot. It is important that to take the ball somewhere the player PUSHES THE BALL OUT IN FRONT, NOT UP AND DOWN, even in a Control Dribble

Travelling is one of the four main areas of turnovers in the game (the others being poor passing, poor shot selection and fouls) and so it makes sense for a coach to teach players how to commence a DRIBBLE WITHOUT TRAVELLING. The travel rule states that on the commencement of a dribble the ball must leave the player's hand or hands before the pivot foot leaves the floor. An easy way to teach players not to travel is to have them STEP WITH THEIR FREE FOOT AND PUSH THE BALL FORWARD AT THE SAME TIME to commence

their dribble. In this way it is not possible to travel as the pivot foot cannot be lifted while the free foot is in the air (that would require the player to jump off the pivot foot or to fall over).

Since the player should be stepping with the free foot into an open space then the ball can safely be pushed into this space at the same time. This requires a two-part movement - BALL AND FREE FOOT AT THE SAME TIME followed by a step with the pivot foot. A travel only can occur when there is a three-part movement - free footsteps and lands followed by ball and pivot foot. It is a natural act of movement to step forward and lift the back foot as the front foot makes contact with the floor (this is the action of walking) as it is the forward movement which causes the back foot to lift, especially as the knees straighten. So a player who steps first and then releases the ball is most likely to travel, especially when trying to execute a quick move. Similarly it is not possible to drag the pivot foot when the ball and free foot are pushed forward at the same time unless, of course, the player over reaches with the step by the free foot and as such movement is likely to be very close to the timing of the release of the ball from the dribbler's hand the referee is unlikely to make the travel call.

The following are teaching points on the various dribbling situations, which a player may be required to use in a game, and therefore which must be practiced.

THE DRIVE - is a dribble which penetrates the ball quickly toward the basket, looking for a close in shot (such as a lay-up or pull-up jump shot) or a pass off to a teammate, both of which create pressure on the defence when the ball penetrates the first line of defence. It is a very effective offensive weapon which all players should be able to use. The various moves a player can use in executing The Drive are called ONE ON ONE MOVES.

Initially The Drive should be taught from a standing position so the player will learn how to avoid travelling and later The Drive can be made from receiving the ball on the move. When a player squares to the basket and is confronted by a defensive player he must look toward the ring, which allows him to see the defence's head and also his teammates cutting toward the basket. By seeing the defence's head the player will be able to read where the defence is moving. If the defence's head moves to his left he is moving left, to his right then he is moving right, backwards mean he is stepping back and if the defence's head comes up it means that he has straightened his legs (therefore little power for quick movement in any direction). Coaches can refer to the section on running and stopping in Chapter 2 to understand that it is the head which initially creates movement.

The offensive player firstly makes his attempt on the side of his free foot, which is also the side where he will be holding the ball. Obviously a move on this side will be much quicker than having to change sides. The basic concept of offence of taking the ball to an open space, the concept of pointing the foot in the direction the player wishes to move, the concept of having knees flexed for power and the teaching of pushing forward with the ball and free foot at the same time to avoid travelling ARE ALL IMPORTANT HERE. If the coach has been consistent in these teachings then the player will feel comfortable about the movement and quickly start to correct himself on mistakes. In addition the extra teaching points will be able to be absorbed more readily as the teaching points mentioned above will already be partly learned.

The ONE ON ONE MOVES are outlined in detail in the following section.

THE CROSSOVER DRIBBLE - is simply a change of direction during a dribble and the basis, as always, is the footwork. The Change of Direction outlined in Chapter 1 is the same footwork used in ALL changes of direction, with or without the ball. The footwork doesn't vary and this is why it is SO IMPORTANT for coaches to continually correct the footwork skills until they are fixed in the player's automatic memory (subconscious mind). The footwork skills must be an automatic response, as must the ball skills so that maximum concentration by the conscious mind can be focus on reading the game and making decisions.

There are three types of Crossover Dribbles and they are - in front of the legs, between the legs, and behind the legs (behind the back). To differentiate between each type of dribble they are referred to as - a CROSSOVER DRIBBLE, a BETWEEN THE LEGS DRIBBLE and a BEHIND THE BACK DRIBBLE Players should learn each type of dribble BUT in this order, due to the need for very good ball handling and awareness in executing the latter two, and this is the way we shall deal with them here. The ONLY variation in the teaching points between all three is the timing at which the ball is pushed across from one hand to the other, to change sides and direction with the ball.

The example we shall use is changing from going right (using the right hand) to going left (using the left hand) in all three dribble situations.

To make a Crossover Dribble the player slows down his speed a little, plants his right foot when out in front, makes a slight pivot on the ball of his right foot and steps with his left foot in the new direction (ALWAYS pointing his foot where he wants to go). AT THE SAME TIME the ball is PUSHED by the right hand ACROSS to the left hand (the right hand needs to slide down the side of the ball to push it across) - BALL AND FOOT TOGETHER rule, IT NEVER VARIES. It is IMPORTANT that the ball be pushed across, NOT DOWN, to gain distance and get the ball to the left hand (and therefore the new position) as quickly as possible. THE BALL MUST STAY LOW on the push across, which in turn HELPS THE PLAYER TO STAY LOW and therefore able TO EXPLODE AWAY in the new direction.

If the player pushes the ball down on the crossover the ball will bounce up higher and therefore cause three problems - not gain as much distance in the new direction, expose the ball to the defence, and cause the player to straighten his legs more and so not have maximum explosive power. As the ball reaches the left hand the player should (having kept his knees flexed) EXPLODE AWAY by stepping with the right foot and PUSHING THE BALL OUT with his left hand (take the ball to the open space), thereby beating the defender, who is now on his right hand side.

In the Between The Legs Dribble the footwork and ball handling is the same except that the position of the left hand is back behind the left knee to receive the ball. Again THE BALL MUST BE KEPT LOW.

For the Behind The Back Dribble the same footwork and the same ball handling applies but now the left hand is positioned further back behind the body to receive the ball. The main problems encountered in the execution of these three dribble situations are - the player straightening his legs and bouncing the ball down not across, the player stepping with the right foot to go left (or left foot to go right), and fingers not spread wide to control the ball.

THE HESITATION DRIBBLE - is a move to lead the defence into thinking that the dribbler may be going to make a Crossover Dribble, causing the defender to start to move his head to the opposite direction to the dribble. The execution for a hesitation dribble with the right hand is for the player to slow down his speed a little, stay low, with the left foot planted out in front hold up the dribble a little at the top of the bounce (ie hesitate the push down) and if the defender's head shifts to the opposite side then the dribbler steps out with a long stride with the right foot and pushes the ball out in front and EXPLODES by the defender.

The FAKED CROSSOVER DRIBBLE - is an extension of the Hesitation Dribble. The execution is the same except at the point of hesitation on the dribble the player rolls his right hand to the outside (right side) of the ball as if to push the ball to his left and as the defence's head starts to shift opposite (that is to the defender's right) then the player rolls his hand on the ball back to the inside (the left side) of the ball and pushes forward, exploding past in the same direction. The advantage of the Faked Crossover Dribble is that if the defender does not react to cover the Crossover Dribble then the dribbler can execute a Crossover Dribble to beat the defender on the opposite side.

THE STUTTER DRIBBLE - is again an extension of the Hesitation Dribble, with the same execution, however as the dribbler slows down he makes a stutter step with his feet (this is a very quick and very short step with each foot) which may cause the defence to slow his momentum and even stand up a little or believe that a Crossover Dribble is about to be made and react to cover this. By putting the defender off balance a little, the dribbler may be able to explode by on the same side as the ball is being dribbled.

These dribble moves are ALL FOOTWORK and BALL CONTROL and PRACTICE, PRACTICE, PRACTICE.

Protecting the ball.

The ball must be protected at all times from the defence. When close defence is pressing a player a part of the player's body must be between the ball and the defence to offer it protection. NEVER allow a player to hold the ball out in front where it is available to the defensive player. A simple teaching rule for this is – DEFENCE, BODY, BALL, that is part of the body between the defensive player and the ball.

Pivoting is the movement that allows a player to maintain part of the body between the defence and the ball. PIVOT AGAINST PRESSURE is another good teaching rule, however the player must always be able to see the ring and the majority of the court (and his teammates). Pivoting to a position that causes the vision to be toward the outside of the court and away from the ring is asking for trouble. Practicing to protect the ball against pressure will help greatly.

One on one skills with the ball.

As in all basketball skills, footwork is 75% of the skill in all one on one moves. The footwork and teaching points explained in Chapter 2 are the same used here. The basic skills do not alter, keeping it simple to teach.

Before teaching the various one on one moves to a player coaches should teach the player how to SQUARE UP to the basket after receiving a pass. Having received the ball and squared up to the basket the player adopts a TRIPLE THREAT POSITION, that is he is ready to PASS, DRIBBLE OR SHOOT (preferably in that order). The technique of squaring up is different when receiving the ball going away from the basket to receiving the ball going toward the basket.

When leading away from the basket the player, having caught the ball in both hands will pivot to face the basket taking the ball to alongside the hip of the free foot (that is the non pivot foot). Feet should be parallel and spaced apart, knees bent, head up and eyes on the ring. If the ball is alongside the right hip then the right hand will be behind the ball ready to push the ball forward for a quick move. If the ball is alongside the left hip then the left hand is behind the ball.

Players must be taught to either make a reverse pivot on their outside foot (that closest to the sideline) or a forward pivot on their inside foot (that closest to the middle of the court) to square up to the basket. In this way the player will be able to see the court, the passer and the basket as quickly as possible. The player should NOT make a forward pivot on their outside foot or a reverse pivot on the inside foot as then they shall initially see the sideline and outside the court area, thereby not being able to execute a quick give and go or one on one move.

As the player comes to catch the ball he must read his defence (seeing the defence and the ball) so that he can decide on which type of pivot to make in squaring up. If the defence is in a triangle toward where the ball is coming from then a reverse pivot on the outside foot will provide an open drive on the baseline side to the basket. If the defence is behind the player as he comes to the ball then a forward pivot on the inside foot will provide an open drive to the middle of the lane. Refer back to the initial teaching on reading the defence and taking the ball to the open space – it never changes. Every skill in this game is simply an extension of the basic concepts and footwork!

When a player receives the ball moving toward the basket the footwork for SQUARING UP is the same, but the preference is usually to make a forward pivot on the inside foot, which allows a player to move into a shooting action much quicker. When moving toward the basket the ball should be taken to the shoulder on the free foot side as the choices here are usually in the order of shoot, pass and then dribble. Now the hands should be positioned so that the hand on the ball side of the body is underneath (allowing for a quick release on the shot). There are FOUR TRIPLE THREAT POSITIONS - one on either hip and one on either shoulder. Player should LEARN to use ALL FOUR TO BE A GREATER THREAT on receiving the ball.

There are 3 basic **one on one moves** and each should be learnt from both right and left hand sides of the player's body. The first is a **jab step and go** (also called an onside move). Here the player takes a short (6inch/5 cm) step with the free foot directly toward the basket and pointed at the outside of the defence's foot on that side. An important teaching point here is that the weight of the player must remain on the pivot foot, not be transferred to the stepping foot, otherwise he cannot move it again quickly. If the defence does not react to this initial move then the player steps forward with the same foot in a longer stride and pushes the ball forward at the same time, placing the ball past the line of the defence's foot. The ball **must not** be bounced downwards near the player's stepping foot as this will not beat the defence and cause the player to stand up more, therefore making him slower. By moving the free foot and the ball together it is not possible for the player to travel. This same timing of movement of foot and ball together is repeated in all dribble moves. Once learnt it never changes and players who do learn this will not cause turnovers by travelling. If the ball is released after the stepping foot has landed on the floor then the pivot foot will be lifting as the ball is released and so the player is likely to travel. The **jab and go move** (or onside move) must be learned with the right foot and right hand and also the left foot and left hand.

It must be the first **one on one move** taught as it allows for the player to find out if the defence will react to his initial movement and if not then the player will gain maximum distance with his long step. Next **the crossover step** should be taught. If, after the player has made his jab step, the defence reacts and moves to cover this step, the player will lift this free foot and step across the defence's feet to the other side and point the free foot at the basket outside the other foot of the defence. The technique requires that the ball be "ripped" across to the opposite side of the body as the foot crosses over. Ball and foot move together. This both protects the ball and has it ready to be pushed forward with the step to beat the defence, without travelling. As the ball is "ripped" across the body the wrists roll the ball so that the hand of that side is behind the ball and ready to push it forward on the dribble. The ball

must not be bounced near the dribbler's feet, as was mentioned above. Again the move should be learned on each side of the body.

The third move that should be learned is the ***jab step and shot***. If, after the initial jab step, the defence steps back and across to cover the drive, the player may bring the ball quickly to his shoulder and rise to make the shot (provided that the backward movement of the defence has created sufficient space for the shot to be made). If on the upward movement of the ball to the player's shoulder the defence's head rises up as he straightens his legs to attempt to pressure the shot, then the player may push forward with a long step, pushing the ball forward at the same time to drive by the defence.

The key point in teaching each of these moves is that the player must ***read the defence*** and make his move opposite to that of the defence. The player must ***not premeditate*** any move – there is no place in basketball for such decisions. In order that the player may read the defence correctly his vision should always be on the ring and he must be able to see the defence's head in that vision. Movement of the defence's head to one side means that is where the defence's weight has shifted and so a quick move in the opposite direction is needed. Obviously no movement means that the defence cannot cover a quick move on that side. When the defence's head rises up it means that his legs are straightening and therefore the more his head rises the less bend in his legs and the less chance of any quick movement (the defence will need to bend down again to move quickly, making him slower). Always stress correct footwork in all one on one moves.

Once the player has beaten the defence in a one on one move his decision of what to do next will be determined by other defensive players. If no one rotates to him he might continue his drive the basket, or pull up in space for a jump shot. If another defence rotates to him he may pass off to an open teammate.

When a player has received the ball going toward the basket and has squared up with the ball at a shoulder, the same one on one moves may be made, however the ball needs to come down from the shoulder to make the dribble. The dribble should still be made into space past the defence's foot. If the player maintains his knees flexed a quick move may still be made with the ball up high. Obviously the jab and shot move is more effective from this squared up position. The same moves are used when turning to face the basket from the low post and high post positions.

As players start to learn the One On One Moves coaches need to continually emphasise that the player must dribble the ball on the right hand side of his body (use his right hand) when moving to his right and dribble it on the left hand side of his body (use his left hand) when moving to his left. As well as protecting the ball (BALL - BODY - MAN rule) the player also has the ball in the correct position for the footwork of stepping right to go right and stepping left to go left. Remember a player who can **ONLY DRIBBLE WITH ONE HAND** well IS **ONLY HALF A BASKETBALL PLAYER**.

The SHOT FAKE may be used in conjunction with the JAB AND SHOOT MOVE or may be used instead of the initial jab step. In both situations the knees **MUST** remain flexed. The player moves the ball quickly straight up to the shoulder in readiness to make a shot (remember the legs must not straighten with the ball movement) and if the defence's head remains down then continue into the shot. However, if the defence's head rises (meaning that his legs are straightening then the player brings the ball quickly straight down the hip area and pushes forward with the ball and the free foot and slices by the defence for The Drive. The SHOT FAKE must be a genuine attempt to make the shot and by reading the defence the player will know whether to continue with the shot or move into The Drive.

In moving the ball upwards for a shot attempt the ball must always travel in a straight line upward (and downward if coming back to The Drive) and must **NEVER** move in an arc, which is much slower.

A player should practice these entire One on One Moves and learn to read the defence. The biggest problem with many players in making a One on One Moves is that they premeditate their action and so often find the defence right where they make their move. Remember, teach players to **READ THE DEFENCE** and then make the best decision.

Low post offence – back to the basket moves.

All players, regardless of their playing position, should learn how to play in the low post. This skill is beneficial in many offences. Again the basis of all low post moves is footwork. Players should learn how to execute all low post moves, both playing with their back to the basket and facing the basket. They should also practice these moves from both sides of the lane.

Low post moves are made either to the baseline side (called a baseline move) or to the middle of the lane (called an inside move). You will notice that the same teaching points are used for the ball work in these moves as in the next section on shooting and in the previous section on one on one moves.

Passing the ball into the low post position offers the offence several opportunities such as a possible scoring move from that position; a pass back outside and a relocation of the post player for another post feed pass and a better scoring opportunity; a pass back outside to a player who has relocated on the perimeter for an outside shot attempt; a pass out from the post to the other side of the court for ball reversal. Having a player in the low post position allows the offence to play an inside/ outside game, causing the defence to have to collapse in on the lane and then to adjust back out to pressure the outside shot or pass.

All players should be taught how to pass to the low post player (feed the post). High passes should be avoided as the post defence more easily deflects these. Players should make a curl pass (see the section on passing) and the pass should be made to the open space in front of the post player, that is to the side of the post player away from the defence. This pass is more difficult to defend by the post defence and allows the post player to stay low and wide to protect the ball and maintain power in his legs for any move he may make.

The position from which to play the low post is so important. The player baseline foot (that closest to the baseline) must either be on the block (in the neutral zone) or above the block on the side of the lane. The player should NEVER start with his baseline foot below the block, as there will be no decent angle to the basket for any move to the baseline side (that is he will be forced to go behind the backboard). The player in the low post position must always play in a low and wide stance. This stance will help to provide good balance and strength against a strong defensive player. It will also maintain power in the legs for any move that is made and also will make it easier for the post player to use his body to block the defence and protect the space in which the ball can be passed to him. Once the post player receives the ball he should take it up under his chin with both hands gripping the ball and his elbows under the ball to prevent it being pulled down. This position for the ball also protects it away from the post defence (remember defence – body – ball). Defensive players will not usually slap at another players face area and holding the ball under the chin provides further protection for it.

The footwork for a back to the basket move is simply two pivots, firstly a reverse pivot followed by a forward pivot. For a baseline move the player makes a reverse pivot on the high foot (the foot furthest from the baseline) and steps with the baseline foot toward the basket, making sure that this foot points at the target area (this pivot is also called a drop step). To move the pivot foot the player needs to make a dribble in order not to travel and so uses a crab dribble. This dribble is made with both hands and the ball is thumped (thrown hard) onto the floor at the mid point of the line between the players feet. In this position the ball is protected by the player's legs and is almost impossible to be deflected. The dribble is just one bounce and must be caught again no higher than the players knees. It is a quick, short dribble only to allow the player to pick up his pivot and put it down again. In addition this crab dribble ensures that the post players will remain down low to have maximum power in his legs for any shot. Any other type of dribble used will be much slower and more open for the defence to deflect (by the post defence or any player helping down onto the post area – this defensive move is called "digging down"). In the same way as for a one on one move the first step (free foot) and the ball (the dribble) must move at the same time to prevent the player from travelling.

As the dribble is caught in both hands the player makes a forward pivot on the foot he first stepped with (the foot closest the basket now) and brings his pivot foot to a parallel position with his front foot. The feet must remain apart (maintain a wide base) and the knees must remain bent for power (stay low).

As the dribble is picked up and the player is completing the forward pivot to face the basket the ball is brought to the shoulder closest the baseline for protection and a quick release on a shot. When shooting close to the basket, players must learn to shoot the ball with either hand. If now the player has sufficient space to make a shot he does so and uses a power shot (see the next section on shooting for the execution of this type of shot).

To make an inside move the player uses the opposite feet. The reverse pivot is now made on the baseline foot and the high footsteps toward the middle of the lane with the foot pointed at that spot. The crab dribble is made in the same way and the player makes a forward pivot on this high foot to face the basket, taking the ball to the shoulder furthest from the baseline, ready to make his move (shot or pass).

If after the post player has made his back to the basket move and is facing the basket, the defence slides across to protect the basket, the post player may be able to make *a step through move*. This is simply a crossover step as in the one on one moves. The player will pivot on his pivot foot and step, with he free foot, across

the leg of the defence (into space) at the same time ripping the ball to his opposite shoulder. He may use a jump hook shot off both legs or rise off the stepping leg for a hook shot. The step through is a very effective move against a defensive player who fights to protect the basketball by sliding across.

Once the player has become proficient at these back to the basket moves he may learn a spin move. This move requires the player to be moving toward the basket as he catches the ball. Now the post player starts his reverse pivot (drop step) early and needs to have that first step on the floor and the next foot in the air as he catches the ball. Now he completes the forward pivot and continues with his power shot or pass or a step through. If the player does not have his first step grounded, then his other foot on the floor will become his pivot foot when this first step touches the floor and now if he lifts his second foot to make the forward pivot and then grounds that foot it shall be a travel. This move requires great timing on both the move by the low post and the feed to him by the passer and should only be learned when the player is well advanced in skill level. In the same way a spin move from the low post using a dribble, to prevent the travel and to gain further distance in the move, should only be taught to advanced players as travelling is a common problem with this move.

In the post position, just like anywhere else in offence, the player must learn to read his defence and move away from the defence into an open space to be available for a pass. The difference in the post position is that the offensive player stays close to the basket and uses his body to block the defence to create an open space. Before outlining the teaching points on how the post player might do this, it is important that the coach and the player understand the various ways in which the post defence might try to defend the post player. In addition to the following descriptions you should also understand the section on **post defence** to be able to read the defence.

There are three ways in which the post defence may try to defend. One method is to *defend the post player from behind* which allows an easier pass into the post position. Sometimes this defence is played more to the side of the post, partly between the post player and the ball. This defence is used to be able to stop the post player going to the basket and to force him away from the basket to receive the ball.

Another method is to defend the post player from the front (called *fronting the post*). This form of defence is used to stop the player from receiving the ball.

A third way is to *half front the post player*, that is to play defence from the side but standing half across the front of the post and is used to both prevent the post receiving the ball and to be able to slide behind the post player should he receive the ball, to prevent him from going to the basket.

The following teaching points for playing against each style of defence will allow the post player to practice moves that will help him to be a threat within the offence.

When played from behind the post player may be able to play the defence by making a back to the basket move or turning to face the basket (for this skill see the next section on **low post offence - post moves facing the basket**). As the post receives the ball and takes it up under his chin he should glance past his foot on the baseline side. If he cannot see the defence's foot, or feel any contact, on that side he may use a back to the basket baseline move to get inside the defence. If when he glances past his baseline foot he sees the defence's foot, or can feel solid contact on that side, he may make a back to the basket inside move to the other side. On each of these back to the basket moves the post player must get contact with his hip on the defence as he reverse pivots, stay low and wide and protect the ball as described above. Alternatively he may make a forward pivot to face the basket to look for a move (see the next section on **low post offence - post moves facing the basket**).

If the defence fronts the post player he may use either of the following moves. The first way is to **pin** the defence. This move requires the post player to forward pivot across the closest leg of the defence (which is usually the leg furthest from the ball) and then use his buttocks/bottom/backside to sit on that leg of the defence to pin the defence in his current position. Now the ball needs to be moved quickly so it may be passed to the space created in front of the post player (that is away from the defence). Now, after receiving the ball, the post player can make a back to the basket move. Depending on which side of the defence he pins, the post player will either make a baseline or an inside move.

Should the post player not be able to pin the defence he may make a reverse pivot into the defence to get contact and pin him from behind or on the same side as the ball. The ball may need to be reversed to a player who can take (pass) the ball to the open space in front of the post player. From this position the post player will simply make a quick move to the basket or to a space away from the defence. To help create some more space for this reverse pivot move, the post player may shuffle a few steps up or down, the lane before making the move to

reverse pivot and pin. The use of the short shuffle steps allows the post player to be ready to make his move at any time. When fronted by the defence it is important that the post player does not get pushed into the restricted area (the 3 second area) and he may have to continually shuffle away to avoid that situation against a stronger defensive player.

Defending the post player in the half front position provides the defence with the opportunity to mostly stop the ball getting to the post player, but if it does then he should be able to slide behind and prevent the post from going to the basket. At least this is the theory of the defence and when executed correctly is the most effective of all ways to defend the post. However the post player can also overcome this type of defence.

Initially the post player should observe the way the defence uses his feet in both his stance and the way he changes sides on the post on a pass. A narrow stance will be easier to pin but also allows the defence to step over more easily. A wide stance is more difficult to pin but also makes it more difficult for the defence to step over. The speed of the change of sides by the defence dictates the speed at which the post needs to move to pin. A wider stance allows easier changes of sides (and adds strength for the defence's move) and a narrower stance makes it more difficult for the defence to fight over the top (less strength due to straighter legs). Too wide a stance results in the same effect as a narrow stance as far as strength is concerned (the legs again straighten).

Once the post player can see how the defence likes to move then he can start to try to pin the defence, always on the side away from the ball. He should use a forward pivot to step over the front leg (that furthest away from the basket) and sit on that leg to pin the defence. If, as the ball moves to that side, the defence is able to step over the pinning leg then the post player reverse pivots with this pinning leg and then forward pivots with the other leg to pin the new front leg of the defence. Any time the defence steps too far forward (away from the lane) the post player should reverse pivot on his rear foot (closest the basket) and spin and pin the defence from the opposite side or the back.

Staying low and wide for balance and strength, keeping the back straight, playing strong and reading the defence are all major points in the execution of post play. Having received the ball, the post player needs to make good decisions on whether to make a move to shoot or pass. Frequent practice of the footwork and playing against strong and aggressive defence will help to improve execution and decisions in the low post position.

Low post offence – post moves facing the basket.

At any time that the low post player is defended from behind and cannot make a back to the basket move he should turn and face the basket by using a forward pivot.

After receiving the ball and taking it up under his chin, the post player should glance down past his baseline foot (the foot closest the baseline) and if he sees a foot of the defence, or feels strong contact on that side, should then make a forward pivot on his baseline foot to face the basket, staying low and wide and bringing the ball to his baseline shoulder. By making this move, when the defence is trying to protect the baseline, the post player creates space up the lane for an inside move. If the defence allows sufficient space he may rise up for a jump shot as his first option. If there is no shot available the post player may fake a shot and then make a crossover step to the inside of the lane for a hook shot of this leg or use a quick dribble with the crossover step to allow him to pick up and replace his pivot foot (refer to the section on *one on one moves and crossover*). Now he may have options such as a jump shot or a jump hook shot or a step through and hook shot from the other side should the defence slide across to protect the basket.

If, on glancing past his baseline foot, the post player sees no foot of the defence or feels no contact on that side he should forward pivot on his inside foot (the foot furthest from the baseline) to face the basket. Now he has created space on the baseline to make his move. Again the first option is the jump shot if space is allowed by the defence and may be followed by any of the options mentioned in the previous paragraph.

Of course the low post player should always be aware of his teammates and be prepared to pass the ball at any time. A pass to the low post position is an effective way to reverse the ball to the other side of the court. Now the post player may be able to relocate in the lane for a return pass.

High post offence.

The low post and high post positions are also referred to as the pivot. The reason is that from these positions the ball may be distributed to other players after the defence has been forced to sag into the lane to help on the ball. They are both very effective positions from which to reverse the ball to the other side of the court.

In the high post the offence is usually defended from the side toward the ball or from behind. Again the same back to the basket moves and facing the basket moves should be learned. The X-OUT LAY-UP DRILL described in the section on shooting is an excellent way of developing the footwork skills for playing with the back to the basket in the high post, especially when flashing up to this position. Many offences use the high post as a pivot position and so passing skills and reading the defence are important skills to learn.

TEACHING SHOOTING IN BASKETBALL

Shooting.

This is the focal point of the game for many players, most spectators and some coaches and for these people it is WHAT WINS GAMES. Of course STUDENTS OF THE GAME realise that there are other key factors that help win games such as good skill execution and good teamwork in offence; aggressive defence; understanding and reading the game; that extra hustle and effort by players; and sound game strategies by the coach.

However, blessed with all these factors A TEAM WILL NOT WIN regularly UNLESS THEY CAN SCORE consistently. This brings us to an important point - there are MANY SHOOTERS in the game of basketball but only a FEW GREAT SCORERS. It is SCORING that IS IMPORTANT, not shooting. Not every player on the team is a scorer and while everyone has the possibility and potential to score, in any team two or three players (the scorers) make the bulk of the scoring.

Therefore it makes sense to GET THE BALL IN THE HANDS OF THE SCORERS most of the time. All players must know their SHOOTING RANGE from the basket and the type of shots they can score with. Outside this range and variety of shots a player should not shoot the ball. DEFENSIVE REBOUNDS by the opposition ARE TURNOVERS and like all turnovers must be diminished. It is NOT THE NUMBER OF SHOT ATTEMPTS the team takes, WHICH WINS the game BUT THE NUMBER WHICH SCORE. Shooting percentage is important!

Some younger and inexperienced players like to emulate their NBA stars and so attempt a range of shots, which have no relevance to their level of athleticism, strength and skill and therefore little chance of scoring. At this point in time THERE ARE NO POINTS AWARDED IN BASKETBALL FOR STYLE, only for made baskets. So the simple mechanics of shooting are much more important than the number of times a player turns the ball around his head, for instance, before shooting. A prime example of an INCORRECT SHOT for many players is THE FINGER ROLL LAY-UP, which is a shot meant to be released over the edge, or within about 10 centimetres, of the ring. For players who can dunk the ball quite easily (ie with both hands) this is a very effective shot. For those mere mortals who play below the ring - the bulk of players in lower standard leagues around the world - this is A WASTED SHOT, as about 20 - 25% actually score at lower levels.

This brings us to another important point - SHOT SELECTION. Shot selection is about shooting in range, the type of shot attempted and getting the ball into the hands of the scorers. As we shall learn later in the section of team offence, SHOT SELECTION is one of the main criteria in winning.

A PLAYER SHOULD LEARN, and practice, ALL of the various TYPES OF SHOTS used in the game of basketball so that when the need arises he may make the correct decision on the type of shot to use. At higher levels a player may be restricted by the coach as to when and where he may attempt a shot from but at beginner and junior levels the player should be allowed to use his variety of shots within his shooting range. Great scorers often do not emerge until after several years of playing.

All good coaches have their players practice skills and game situations at GAME SPEED and yet so many players practice their shooting by standing still and shooting the ball (I call this geriatric shooting). Shooting must be practiced at GAME SPEED and in all types of game situations. Five minutes of explosive shooting practice (in 30-second sets) is far better than 30 minutes of standing around shooting "garbage shots".

Another trap for the inexperienced player in the type of shot he uses is the cry "GREAT SHOT" often made by his teammates, spectators and sometimes coaches. So often the great shot is a lucky shot. How can a shot be a great shot if the player only makes one out of ten attempts? Players should be rewarded for good decision making and correct execution, not for lucky shots which will only encourage him to "jack up" more "prayer shots". Coaches could do well to reward players with words such as - GOOD SHOT SELECTION, GREAT EXECUTION - which will soon educate team members to also use such words. REWARD EFFORT AND SKILL, not luck.

Of ALL THE SKILLS in basketball that a coach has to teach, SHOOTING TECHNIQUE IS THE EASIEST for the player TO LEARN. Provided that the coach has taught correct footwork and ball handling skills and helped the player to understand the bio-mechanics of the body, the TECHNIQUE of SHOOTING is very simple as it IS THE SAME ACTION FOR EVERY TYPE OF SHOT! So why isn't everyone a great scorer? The answer is because of a lack of four things - correct practice, strength, flexibility and decision making. In addition to the work done in a weight gym and on the fitness track, strength and flexibility will increase with regular, correct shooting practice. Decision making will improve with increased understanding of and reading of the game. It is all a matter of time, of practising correct technique under game conditions and situations and starting at an early age.

THE SHOOTING TECHNIQUE - as with all skills starts at the feet and works up the body. The feet should be pointed at the target (the ring, or the vertical line on the side of the small rectangle on the backboard for a shot close in on the side of the ring) and spread apart for balance, knees must be flexed for power (most of the power comes from the legs), elbow under the ball and pointed at the target, shooting hand under the ball with the fingers and side of the thumb spread wide and gripping the ball, the non shooting hand fitted on the side of the ball with fingers and thumb spread wide and gripping the ball and the fingers pointed vertically, shoulders square to the target. To shoot the ball the player pushes with his legs followed immediately by pushing his elbow upwards toward the target until his arm is fully extended and as the ball releases from the fingers of the shooting hand, breaks the wrist downwards to provide backspin on the ball, keeping the fingers spread apart. Immediately after the release of the ball the shooting hand wrist must be level and pointed at the target (this is called the follow through). The non-shooting hand fingers will straighten as the ball leaves them, (which is just prior to the ball release from the shooting hand) and these fingers will guide the ball straight toward the target.

Understanding the reasons why we do things is an important part of learning and so players should understand how each part of the shooting technique is broken down and why each is so important. Firstly the feet and legs. As we learned in Chapter 1 on footwork the maximum power from our legs is directed where our feet (and therefore our legs) are pointed. Since most of the power for the shot comes from the legs it is logical to have them pointed where we want the ball to go - at the ring (or target). Secondly, basketball uses a goal, which is different to all other sports (except netball - a similar sport), in that the goal is horizontal, not vertical as in soccer, hockey, rugby, the entire net sports etc. IN THESE OTHER SPORTS which have a vertical goal THE BALL IS SHOT AT THE GOAL mostly in a horizontal trajectory. IN BASKETBALL with its horizontal goal WE need to SHOOT THE BALL in a vertical trajectory, that is UPWARDS to have it fall into the goal. For this reason the elbow must be under the ball to push it up, creating a vertical arc. Thirdly, when the ball is released from the shooting hand THE SHOULDER on that side ROTATES automatically THROUGH AN ARC (of about 23 degrees I have read - but don't ask me how it was measured so exactly). Therefore if the shoulders are not squared to the ring (target) the shooting arm will not extend directly at the target, causing the ball to be released more from the side of the hand. The ball should spin backwards keeping it on a straight line and softening the contact with the ring or the backboard, helping the ball to fall into the ring.

Some of the COMMON ERRORS IN SHOOTING TECHNIQUE are - the feet being pointed away from the ring which diminishes the power toward the ring and causes the player to use extra action with the arm and shoulder from further out, thereby reducing the range and accuracy. The knees do not have sufficient bend, therefore reducing the power and causing the player to "heave" the ball at the ring by using extra action from his shoulder. Bodyweight is more on one leg than the other, causing the hips to rotate as the legs straighten and therefore the shoulders to swing in the same direction. The elbow is behind or in front of the ball, which causes the ball to have a flat trajectory, and therefore minimises the chance of scoring. The elbow is pointed out to the side of the body causing the ball to go to that side of the ring (the elbow can only straighten where the elbow is pointed - just like the leg can only move and straighten where the foot/knee is pointed). The ball is gripped by the pads of the fingers and not by all of each finger. The pad of the thumb is on the ball, not the side of the thumb (causing the ball to come up onto the pads of the fingers). The off-hand (non-shooting hand) has the fingers pointed forward or is situated on the ball too far forward or back, each of which will cause the ball to rotate sideways. The off-hand does not release at the correct time in the shooting process causing the ball to fall short or be shot with both hands, often one more than the other which causes the ball to veer away from the target. The shoulder of the shooting hand is turned toward the ring causing the arm to extend sideways creating poor direction and sideway spin. The shoulders are leaning back when they should be slightly forward. The head is not in the middle of the body or it may be back or to one side (slightly forward is OK). If the head lifts to follow the flight of the ball it causes the shoulders to move backwards and the ball to fall short. These errors can be corrected by taking the player back through the basic shooting technique practice for that particular shot outlined in the following section.

For beginners the easiest and most effective shot to learn is the SET SHOT, a shot, which has both feet on the floor for good balance and power from the legs. It is this shot which I shall use to explain the teaching sequences for shooting and then explain the variations in teaching the other common types of shots used in basketball today. I should remind coaches that the size of the ball should fit the size of the player's hand, that is a size 5 ball for small hands (mostly under the age of 12 years) and a size 7 ball for larger hands. If the ball is too big for the size of the player's hand then bad habits will be formed from the beginning. The player must be able to have a comfortable grip on the ball.

Coaches of experienced players will also find the following sequences helpful as a checklist for correcting shooting technique errors and as a practice routine for players.

TEACHING THE SET SHOT requires 3 sequences (I shall use the right hand only in this example). The FIRST SEQUENCE is to have the player stand to the right hand side of the ring and just one step out from the centre of the ring (that is very close to the backboard and ring). Have the player adopt the correct stance, that is feet pointed at the vertical line on the backboard, knee flexed, elbow under the ball and pointed at the target (the vertical line), fingers spread wide apart and gripping the ball (called *The Grip*) with all of each finger and side of thumb (not just on the pads of the fingers), head up and in the middle of the body and eyes on the vertical line (the target). The ball should be held only by the shooting hand and at shoulder height with the bent arm close to the shoulder, keeping the elbow under the ball. In a set shot the eyes sight the target (the vertical line on the backboard) over the top of the ball. To shoot, simply straighten the legs, at the same time pushing the elbow upwards until the arm straightens, breaking the wrist down sharply as the ball leaves the index and middle finger, maintaining all fingers spread apart. In this first sequence the player is learning to control the ball with one hand and to direct the ball to the target with correct trajectory (starting further out from the target will cause the player to use a flat trajectory that will most probably remain through his career). In addition the player is learning to score consistently (getting the correct “picture” on his subconscious mind – automatic memory as some now call it). After 5 –10 attempts the player can then move to sequence two.

THE SECOND SEQUENCE is to move back one more step from the backboard and repeat the sequence (only one hand is still used). Now the legs need to come into play more. The sequence of movement becomes important – that is the legs starting to straighten first, followed by the straightening of the arm (a continuous motion of the legs and the arm – not two separate actions). The trajectory of the ball continues to be almost vertical. All previous shooting techniques from sequence one must be followed.

THE THIRD SEQUENCE is to then take one more step away from the backboard. Now the left hand is added to the side of the ball, fingers pointed straight up and with each finger and the side of the thumb gripping the ball. Both arms move vertically and the fingers of the left hand straighten just before the release of the ball (the ball is pushed past the straightened fingers of the left hand – to guide the ball toward the target). All the previous techniques of sequence one and two are repeated. By remaining close to the basket the player is reinforcing correct technique and scoring.

These learning sequences may be used for learning the correct technique for every basketball shot and are often practised by experienced players at the commencement of shooting practice in order to reinforce correct shooting technique.

As the player continues to practice and to learn to shoot further from the basket it is important that scoring be the major focus, along with correct technique. As the player moves further from the basket the only part of the technique that alters is that the legs bend a little more and straighten (push) up a little quicker and the pushing up of the elbow moves a little quicker. The further from the basket that the ball is shot, the more bend and quicker release is required.

As the player moves further from the basket, the coach (and player) should be aware of any dropping of the shooting shoulder in order to get more power into the shot to make the distance. If this occurs then the player is out of his shooting range and needs to move closer to enable correct technique to be practiced. As the technique becomes more fluid and the strength of the legs and arms increase then the player will be able to shoot, and score, from further out. Any incorrect habits learned at the beginning will be difficult to change later on and will result in poor scoring, especially against strong defence. As the player moves outside the key (lane) the target should only be the ring. The player may use the closest edge of the ring as a target, or the back of the ring. It doesn't seem to matter, which is used provided that the player always uses the same area on the ring as the target.

To find his shooting range the player starts shooting close to the basket and each time he scores he takes a step backwards and increases the distance. If a shot misses he steps forward to take the next shot. When the player is consistently missing from a spot then that is out of his shooting range, at this time. Shooting out of range cause the player to adjust to poor shooting techniques to try to make the distance to the ring. It also reinforces missing, instead of scoring, on his subconscious mind.

TEACHING THE LAY-UP is just like teaching the set shot, by breaking down each part of the shot process and using the three sequence method. Because the lay-up is a running shot, as compared to a standing shot like the set shot, it often seems more difficult to teach. By following the three sequence method players can quite quickly learn the technique and be able to make a shot without travelling. Again the example used here is with the right hand. In a left hand lay-up the opposite feet are used for each step. The technique outlined for learning a

lay-up (or any other shot) is almost the same as for the set shot, the differences being in the footwork and where the ball is held and shot from.

THE FIRST SEQUENCE is to have the player stand to the right hand side of the ring and just one step out from the centre of the ring (that is very close to the backboard and ring). Have the player adopt the correct stance, that is feet pointed at the vertical line on the backboard, knee flexed, elbow under the ball and pointed at the target (the vertical line), fingers spread wide apart and gripping the ball with all of each finger and side of thumb (not just on the pads of the fingers), head up and in the middle of the body and eyes on the vertical line (the target). The ball should be held only by the shooting hand and at shoulder height with the bent arm close to the shoulder, keeping the elbow under the ball. In a lay-up the eyes sight the target (the vertical line on the backboard) over the top of the ball. As the lay-up is a running shot we should emphasise the footwork first, while also teaching the release of the ball. The player should take a small step forward with the left foot, with knee bent, and then jump upwards off that leg and as he does that also move his elbow upwards and as the shooting arm straightens, release the ball onto the backboard breaking the wrist down as the ball is released. In this first step the player is learning to jump upwards off the correct leg and to control the ball with one hand and to direct the ball to the target with correct trajectory (starting further out from the target will cause the player to jump forward instead of upwards and to use a flat trajectory, both of which are bad habits that will most probably remain through his career). In addition the player is learning to score consistently (getting the correct “picture” on his subconscious mind – automatic memory as some now call it). After 5 – 10 attempts the player can then move to sequence two.

THE SECOND SEQUENCE is to move back one more step from the backboard and repeat the first sequence. Now we have the player take a larger step forward towards the target with the left foot to be able to jump upward off that leg at the same spot as in step one. Also now the left hand is placed on the ball, as in sequence three of the set shot. The action of the left hand is exactly the same as in the set shot, that is the left hand is added to the side of the ball, fingers pointed straight up and with each finger and the side of the thumb gripping the ball. Both arms move vertically and the fingers of the left hand straighten just before the release of the ball (the ball is pushed past the straightened fingers of the left hand – to guide the ball toward the target). Now the legs need to work a little harder to enable the player to both take a bigger stride step and to jump up higher. The sequence of movement becomes important – that is the legs starting to straighten first, followed by the straightening of the arm. It is almost as if the legs are pushing the ball to the target. The trajectory of the ball continues to be almost vertical. All previous shooting techniques from sequence one must be followed.

THE THIRD SEQUENCE is to then to take one more step away from the backboard. Now the player steps toward the target with the right foot followed by the left foot and then jumps off the left foot as in the first two sequences to release the ball with the same technique. After 5 – 6 attempts at this the player should be ready to advance to the next part of learning this shot. From the same position the player bounces the ball at his right side and as he picks up the ball he steps forward with his right foot as in the earlier part of this sequence. At the same time he takes the ball to his right shoulder with the correct grip and positioning of the elbow under the ball. He continues the shooting action by following with the left foot and jumping to shoot the ball as before. After the player seems able to handle this action reasonably well (do not wait for him to be perfect) then he can take another step back away from the basket and now take two dribbles toward the target, always stepping with the right foot as he picks up the ball. The rest of the action is as before.

Players vary as to how quickly they learn each of the skills in basketball, some are more coordinated and confident, and others take longer. The action of the lay-up is no different and with a little patience and a few sessions most players will soon be able to make a correct lay-up. As soon as the player seems able to handle the right hand lay-up on most tries then it is time to start with the left hand lay-up. Beginner players who are naturally left handed should start with the left hand lay-up for confidence, and then they can act as a role model for right handed players (and vice versa).

The two worst habits that a young player can develop in a lay-up are the act of jumping forward rather than upwards and using an underhand action to shoot, such as in a finger roll shot. As in all shots, learning the correct technique at the beginning will develop a scorer and not just a shooter.

TEACHING THE JUMP SHOT uses the same method as in the two previous shots, that is with three sequences. In the following teaching points only those parts of the shooting technique that vary from the basic shooting technique (the position of the ball and the footwork) are explained. All other parts of the basic shooting technique are the same for the jump shot, as for all other types of shots in basketball. Again the right hand is used in this explanation.

THE FIRST SEQUENCE is the same as in the previous descriptions except that the target is sighted under the ball. The ball is held in the right hand (check the grip) to the side of the head and above the level of the right eye (right thumb should be just above the right eyebrow). Sighting is done by lifting the eyes to see, not by tipping back the head (this causes the shoulders to move back and the ball to fall short). The player jumps off both feet with a small jump and releases the ball from this elevated position just as in the set shot (pushing the elbow straight up and using the follow through).

In THE SECOND SEQUENCE the action is the same as for the set shot and now the jump is made much higher (more effort from the legs) and the correct execution of the sequence of the jump shot is learned, that is the jump followed by the release. At young ages and early stages of learning the jump shot, it is better that the player makes the release on the way up, that is before reaching the peak of the jump. Later as the legs and arms develop more strength the shot can be released at the peak of the jump. If the younger or inexperienced player tries this latter method of release the ball will usually be thrown instead of being pushed upwards as it should be.

The THIRD SEQUENCE for teaching the jump shot is the same as for the set shot. Now the off hand is added and correct release for a good trajectory is emphasised as well as a high jump. The jump should be straight up or slightly forward, never backward (use a mark on the floor to check this).

Once the basic technique for the jump shot can be performed most of the time then learning the shot in action can be undertaken. Initially the player should learn to shoot off a pivot. When receiving the ball moving toward the basket the player should always square to the basket on the inside foot (the foot closest to the ring). For right handed players learning to make a jump shot off a pivot it is easier to start with a pivot on the left foot (that is moving toward the right hand side of the court) as this allows for the player to move into the shot on the natural side (obviously the opposite is true for left handed players). To learn the player starts with the ball in the shooting position and side on to the basket. He steps forward with the left foot and pivots on that foot so that it faces the target and then brings his right foot to also face the basket, at the same time keeping the knees bent (*this is most important*). The feet should end up about shoulder width apart and with both feet parallel or the right foot slightly in advance of the left. To shoot the player jumps up and releases the ball in the correct manner. Ensure that the player starts in close to the ring (to reinforce scoring) and that the movement from the commencement of the pivot until the release of the shot is **continuous**. Once the player is comfortable with this movement a dribble (later two) can be added, just as it was used in teaching the lay-up (be sure to prohibit travelling). From here the player can advance to moving toward the left hand side of the court to learn this shot (now the pivot will be on the left foot). This movement may seem awkward at first as the player does not naturally move into the shot, but it should soon feel OK. The ball now needs to be brought across the body to the right hand side of the head (a good grip will help to not lose the ball). The feet should end up in the same position to make the shot as for a pivot on the right foot (that is right foot – the shooting foot - slightly in advance of the left foot always for a right handed shooter, or feet parallel).

Later the player should learn to shoot of a jump stop (a pull up jump shot). Now the player moves directly at the basket and then jumps to land on both feet simultaneously and then jumps up to shoot. The player **must not** stay on the ground upon landing but **bounce immediately** (a plyometric action) into the air to make the shot (now you are developing the catch and shoot action – the quickest shot in the game). The ball must come to the shooting position as soon as it is picked up. The ball should never be shot from the hip upwards as a continuous motion (if the player learns to make the shot in this way then later on he may not be effective at a shot fake or dish off). Also the player should not be allowed to dip the ball downwards as he licks it up (it must come straight up to the side of the head).

Later the players should learn to use this shot off the dribble and off the pass, going left and going right (refer to shooting drills later on for examples).

The question is often asked of how old should a player be before the jump shot can be taught. In my opinion as young as 12 or 13 years of age, depending on the players strength of legs and shoulders. A good guide is when the player can consistently shoot the ball above the basket with one hand from the edge of the lane/key (that doesn't mean score). It takes little time to learn a basic jump shot (I have had players learn in 20 minutes to pivot off a dribble and shoot a jump shot) but continual correction is necessary for the player to be successful as a scorer.

Keep in mind the importance of learning to shoot in range, both for scoring and good technique. In my opinion the worst skill in international basketball today is the inability of many players to consistently hit the 15 – 18 foot (5 – 6 metre) jump shot, and it is mostly due to poor technique learned at a younger age (so many players throw or force the shot). In some under 12 age competitions the 3 point shot is banned, a way of addressing this very situation.

If, as a coach, you could eliminate all finger roll lay-ups, jumping forward on lay-up shots and shooting out of range then I guarantee that you would dramatically reduce the team turnovers and maybe increase your scoring (and your shooting percentage). If you are coaching a young age team then you will certainly develop more scorers than shooters. One day some senior coach will thank you for that, and most likely the players also.

The jump shot is the most commonly used shot in basketball today. Teaching a player to use it successfully is no more difficult than teaching it incorrectly.

TEACHING THE POWER SHOT follows the same sequences and teaching points as for the jump shot with one difference. The power shot is released on the way up, which is before the peak of the jump. It is as if the legs power the ball to the backboard or ring. The arms must remain strong throughout the shot. This shot is usually made with close defence, such as from the low post position, and therefore needs to be explosive and made with a strong move.

TEACHING THE HOOK SHOT is just as simple as the previous shots. The action of a hook shot is really similar to a side-on lay-up. The following alterations to the three sequences for teaching the lay-up will allow you to continue the KISS Method of teaching shooting. Please refer back to the steps for teaching the lay-up and teach the same arm movement and ball release, but with the alterations for footwork.

In the FIRST SEQUENCE the alteration is that the player stands side onto the ring with the feet pointed at the backboard. As the player takes the small step forward with the left foot he also makes a small pivot on that foot turning his body about a quarter turn toward the basket before he jumps upwards to release the ball onto the target (the vertical line).

This alteration to the footwork is the same for the SECOND SEQUENCE.

In the THIRD SEQUENCE the same footwork as above is used and the off-hand now comes off the ball earlier and stays high between the shooting arm and the basket with the elbow off this off-arm remaining bent. This off-arm becomes a protection (as is the body also) for the shooting hand and the ball. The hook shot is a shot designed to be used to shoot the ball closer around the basket and over the top of the defences arms. It is an excellent shot for all players to learn for playing in the low post position and should be learned with both right and left hands (just like the lay-up).

The hook shot is released with the elbow under the ball, as for all basketball shots. The arm should not be held out straight and released with a round-arm action. This action is the basis for the “*sky hook*” shot, made famous by Kareem Abdul-Jabbar, and is for shooting down into the basket. In all shots where the ball is being shot upwards the elbow must be under the ball before release in order that the correct arc can be used to score.

TEACHING THE JUMP HOOK SHOT is easy after the hook shot has been learned. The only difference for this shot as compared to the hook shot is that after making the pivot on the inside foot, the player then jumps off both feet, instead of off one foot as in the hook shot. The jump hook shot is more of an explosive, power shot inside and close to the basket. Again it should be learned with both right and left hands. This shot is the most effective shot inside the lane/key against inside defence.

SHOOTING DRILLS comprise more in number than for any other skill in the game of basketball. Regardless of what drills are used one thing remains important above all others – PRACTICE AT GAME SPEED. It is also important that players practice the type of shots they will use in the game (that is relevant to age and standard). As I said earlier in this chapter, 30 – 60 seconds of explosive shooting practice, followed by a rest then repeated again for five sequences then finish, is far more effective practice than 30 minutes of shooting around at a slow pace. *Quality is more important than quantity, provided correct technique and scoring remain paramount.*

All players should learn to shoot with both left and right hand around close to the basket (lay-up, power shot, hook shot, jump hook shot) and with their strong (natural) hand outside (jump shot, set shot).

As there are so many shooting drills available I shall only describe a couple for each type of shot. These are drills that I have found to be most effective in practicing shooting at game pace.

X-OUT LAY-UPS: The player starts at the right hand elbow of the lane/key and makes one dribble, picks up the ball with the right hand and takes the correct steps to make a right hand lay-up. He then rebounds the ball and dribbles with the right hand to the left hand elbow, where he makes a reverse dribble, a crossover dribble to the left

hand and takes one dribble with that hand to pick up the ball in his left hand and takes the correct steps to make a left hand lay-up. He then rebounds and dribbles with the left hand to the right elbow and makes a reverse dribble, a crossover dribble to the right hand and takes one dribble with that hand, picks up the ball and takes the correct steps to make a right hand lay-up. The drill continues for 30 seconds (or 5 lay-ups with each hand).

A variation of this drill is to have two partners (and two balls), one partner to rebound and one to place a ball at each elbow. Now the shooter runs to the elbow, bends low to gather the ball, makes a drop step (reverse pivot) with the outside foot, forward pivots on that foot to face the basket, takes a dribble with the outside hand and takes the correct steps to make a lay-up from that side.

SET SHOT OFF THE DRIBBLE: Starting out at the top of the lane the player makes a right hand dribble to the right side of the ring, picks up the dribble with the left foot (inside foot) on the floor, forward pivots on that foot as he takes the ball to the right side shoulder with elbow under the ball, brings the right foot square to the ring and slightly in advance of the left foot keeping both knees bent and rises to make the shot. The player then rebounds the ball, runs to the top of the lane and then makes a left hand dribble to the left side of the ring, picks up the dribble with the right foot (inside foot) on the floor, forward pivots on that foot as he takes the ball to the right side shoulder with elbow under the ball, brings the left foot square to the ring and slightly behind the level of the right foot keeping both knees bent and rises to make the shot. The drill continues for 30 – 60 seconds.

SET SHOT OFF A PASS: This drill is the same as the previous one except now the player spins the ball out in front of him (passes to himself) and moves after the ball to catch it. As he picks up the ball he makes the pivot on the inside foot and continues as explained in the previous drill.

A variation to this drill is that on picking up the ball and making the forward pivot the player takes one or two dribble/s in the same direction and now completes the shot as in SET SHOT OFF THE DRIBBLE. A shot fake can be incorporated before using the dribble, to add variety to the drill. A further variation is to make the dribble to the opposite direction that the pass is made. In this move a crossover step will need to be made so the player does not travel. Even further variation can be added by using a jump stop on catching the pass (and turning in the air to land facing the basket). Now the left foot can be used to go left with the dribble and vice versa for the right foot (that is a jab step or onside move is made – no crossover step is necessary, therefore gaining extra distance quickly).

JUMP SHOT OFF THE DRIBBLE: This drill is the same as for the SET SHOT OFF THE DRIBBLE except now a jump shot is made. Remember to keep the knees bent until ready to come up for the shot.

JUMP SHOT OFF A PASS: The same as for the set shot drill off a pass. The variations explained there can be used for the jump shot.

PULL UP JUMP SHOT OFF THE DRIBBLE: The player starts with the ball out near the centreline and uses a speed dribble to take the ball to the edge of the lane. Here he picks up his dribble using a jump stop and explodes to a jump shot (catch and shoot – do not stay on the floor on landing but bounce straight up again). Remember after picking up the dribble to take it immediately to the shooting position with elbow under the ball. Then rebound the ball and walk back to the centre line and repeat the move. The spot on the court from which the ball is shot should be varied.

A variation of this drill is for the player to pass the ball to himself to make the shot off the pass. The pass should be made from well outside the 3 point line so that the player is moving at speed when he catches the ball.

POWER SHOT OFF A LOW POST MOVE: Low post moves are explained in the previous chapter. The player should use all moves – baseline and inside moves both on the left and right sides of the lane.

HOOK SHOT OFF LOW POST MOVES: Again refer to the previous chapter and the use of the step through move. This move utilises the hook shot.

MIKAN DRILL (HOOK SHOT): The player starts one step out in front of the ring, steps with the left foot to the right hand side of the ring and makes a right hand hook shot. He then rebounds the ball and steps with the right foot to the left hand side of the ring and makes a left hand hook shot. The drill continues for 30 – 60 seconds. This drill is named after the first big man in the NBA – George Mikan.

A variation of this drill is (starting from the same position) to take a right hand dribble to the right side of the ring, pick up the dribble and come to a jump stop, make a forward pivot on the left foot and then step forward in front of the ring with the right foot for a left hand hook shot. After rebounding, the player takes a left hand dribble to the left side of the ring, picks up the ball and comes to a jump stop, makes a forward pivot on the right foot and then steps with the left foot toward the front of the ring to make a right hand hook shot. The drill continues for 30 – 60 seconds.

An important part of the technique in this move is that the ball must be taken to the shoulder on the side of the free foot as the forward pivot is being made (that is with a forward pivot on left foot the ball is taken to the right shoulder). In this way the player is learning to protect the ball with his body. On the step forward with the right foot the ball is “ripped” across the upper body to the left shoulder to make the left hand hook shot (always the elbow is under the ball ready to make any shot).

JUMP HOOK SHOT OFF A PASS: This drill requires two partners and two balls. One partner is positioned outside the lane and above the line of the block (neutral zone) on each side of the lane, each with a ball. The player starts from the edge of the lane on one side and flashes toward the other side. The partner on that side passes the ball to him just before the player reaches the front of the ring. The player catches the ball and makes a jump hook shot, then rebounds and passes back to the same partner and follows the pass to that edge of the lane. Here he pivots to face the other partner and now flashes toward him again receiving a pass at the front of the ring for a jump hook shot. He then rebounds and passes back to that partner, follows the pass to the edge of the lane, pivots and repeats the movement to the other side. Break after 30 – 60 seconds and rotate players.

A variation of this drill is after receiving the pass, the player fakes a shot, and forward pivots on the inside foot and makes a slash through move with the ball and the new inside foot to make a jump hook shot with the opposite hand. A dribble can be incorporated with the slash through move if desired, followed by a jump hook shot on the other side of the ring.

If no partners are available then the basic drill can be done by the player dribbling in from the edge of the lane for a jump hook shot. Then the player, after rebounding the ball, dribbles to the opposite edge of the lane, makes a reverse dribble or spin move and repeats the drill. Remember to dribble with the correct hand, that is with the right hand going right and left hand going left.

Players should also practice shot fakes after catching the ball, followed by a shot or another move (without travelling). A shot fake is performed with the LEGS BENT and only the ball moves up, the legs remain bent to provide power for the shot or move that follows. The BALL SHOULD MOVE STRAIGHT UP as if going to make a shot attempt. The ball should not move out away from the body in a forward movement. The shot fake must be realistic, not a little wave around with the ball. Good defence will not fall for such a poor move.

TEACHING POINTS ON SKILLS AND TOPICS

INDIVIDUAL OFFENCE

BASIC CONCEPTS

Understand and be able to teach first the basic concepts of offence and defence in basketball and other sports

Offence – the concept is – *Take the ball to the open space.*

- moving into an open space away from the defence using changes of direction, take the ball to the person in the open space and move to another open space

Defence – the concept is - *Stop the ball* getting to the goal

FOOTWORK

MOVEMENT:

- knees bent for power
- head forward for movement
- feet point in direction of movement
- quick first step
- step with left foot to go left, step with right foot to go right

STOPPING:

- use jump and stride stop
- wide base with feet
- low centre of gravity (hips low)
- head back over feet (base)
- stop quickly and stay down for next quick movement
- pivot to square up or see court
- head up for direct and peripheral vision

CHANGE OF DIRECTION:

- pivot on right foot and step with left foot to go left
- pivot on left foot and step with right foot to go right
- get low to change direction and explode away with quick step

PIVOTING:

- stay low, wide base
- head up for direct and peripheral vision
- use ball of foot to pivot on and take short steps
- keep hands up

LATERAL RUNNING:

- feet pointed in direction of movement, upper body turned toward ball, hands up

- in turning, always face the ball
(ie always pivot inside by using correct footwork in change of direction)
- head up for direct and peripheral vision

BALLWORK

BALL HANDLING:

- fingers spread, ball on fingers not on finger tips
- grip the ball
- find and feel the ball with the fingers, do not look at it
- be quick to gain confidence and competence

DRIBBLING:

- correct height of dribble
- take the ball somewhere, do not dribble at the feet
- push the ball out and step out to go to a speed dribble
- develop use of right and left hand
- stay low in a control dribble
- explain the two reasons to use a dribble - to penetrate/retreat or to improve a passing angle

CATCHING / RECEIVING:

- fingers spread and pointed forward and up a little, thumbs pointed inwards, elbows bent
- move (step or run) toward the ball until it hits the thumbs and close the fingers on the side of the ball and grip it, eyes on ball into the fingers
- on catching the ball land with a jump stop or stride stop and pivot to pass or square up, keep knees bent and head up for vision

PASSING:

Teach the types and situations used in a game.

- passing versus dribbling
- types of passes and when to use them
- passing angles
- using a dribble to create a better passing angle
- penetrating passes versus cross court passes
- the use of a pass to reverse the ball

INDIVIDUAL OFFENSIVE MOVES

V-CUTS:

Players use V-cuts (change of direction) to get open and then square-up to a triple threat position. Emphasise all previous teaching points.

ONE ON ONE MOVES:

Have players execute 1 on 1 moves of jab and go, jab and crossover, jab and shoot and shot fake. Emphasise:

- stay low, head up for vision
- parallel stance, weight forward
- step out and push ball out at same time to avoid travelling
- do not dribble at feet, push ball out in front of front foot as stepping
- grip the ball with both hands and hold the ball on the side to be used for dribble (not in front)
- reading the defence by seeing the defence's head

LOW POST MOVES:

Players should begin to execute low post moves - back to the basket, both baseline and inside. Stress:

- hold ball under chin
- feet apart and knees bent for power and stability
- crab dribble without travelling
- ball taken to shoulder opposite the defence
- power shot, not jump shot, off both feet

Players should begin to execute low post moves - turn and face. Stress:

- hold ball under chin
- feet apart and knees bent for power and stability
- ball taken to shoulder opposite the defence
- jab and go, jab and crossover step to power shot, not jump shot, off both feet
- shot fake and jump shot

OFFENSIVE REBOUNDING:

- read the defence
- with no contact use footwork to step across defence
- with contact spin off with reverse pivot to get inside
- be aggressive to keep the ball alive

SHOOTING:

Emphasise the need to learn and execute correct shooting technique, specifically for lay-up, set shot and jump shot.

- feet pointed at target
- knees bent for power
- eyes on target
- elbow under ball and elbow pointed at target
- grip the ball with fingers, not finger tips
- off hand on side of ball with

- fingers pointed straight up and thumbs at right angles
- push elbow up and follow through and break wrist as ball leaves the fingers

TEAM SKILLS

PASS AND CUT / GIVE AND GO:

- the individual skills of V-cut, square-up, triple threat
- the cutter setting up the defence and reading the defensive player
- on every pass cut (move/relocate)

SCREENING:

Teach the difference of screens on-ball and off-ball. Stress the need to read the defence.

Rules for the cutter:

- if the defence follows over the screen, go to the basket
- if the defence goes behind the screen, go to the ball
- if the defence steps over the screen early, go backdoor

Rules for the screener:

- if the cutter goes to the basket open and go to the ball
- if the cutter goes to the ball open and go to the basket

THE 2 ON 2 GAME:

Teach the 2 on 2 game, both with and without the ball and how it fits into team offence.

- read the defence
- pass and cut
- cut and fill
- cut and replace self
- pass inside and relocate
- maintain good spacing
- always be available for a pass or a rebound

TEAM OFFENCE

OFFENSIVE CRITERIA FOR BEATING THE DEFENCE:

- create a side of the court (get the ball out of the middle)
- take the ball below the free throw line (flatten the defence)
- take the ball inside (make the defence collapse)
- reverse the ball

RULES FOR EVERY OFFENCE:

- maintain good spacing
- maintain court balance
- movement of ball and players
- use patience and timing
- good shot selection

INDIVIDUAL DEFENCE

FOOTWORK

MOVEMENT:

Players need to learn the footwork skills of sliding (shuffling) sideways and backwards and forward and also change of direction. At the same time they should learn peripheral vision and special awareness. :

- leading foot pointed to sideline
- stepping out with right foot to go right and with left foot to go left
- stay low and take short quick steps, keep shoulders back
- do not jump, always have one foot on the floor
- step with each foot, do not slide the rear foot
- keep hips pointed toward sidelines (back to the baseline)
- change direction as for forward movement

ON-BALL DEFENCE:

Teach on-ball defence and emphasise the teaching points:

- playing between ball and basket
- beating the offence with the first step
- playing with back to baseline and directing ball to sideline
- at all times prevent penetration of the ball into the lane (key)
- maintaining space from the ball handler
- use of arm bar to bump off and leading hand in the passing lane

OFF-BALL DEFENCE:

BUMPING THE CUTTER:

Teach bumping the cutter, defending the flash cut and reading the offence.

LOW AND HIGH POST DEFENCE:

- half front on the low post and change side by fully fronting
- half front on the high post and change sides by sliding behind
- need for help defence when fronting the post

TEAM DEFENCE

MAN TO MAN

HELP AND RECOVER:

The concept of help and recover man to man defence needs to be taught before any zone defence as its' principles are part of executing all team defences. Firstly teach the adjustments by the defence in relation to ball movement and player movement, including baseline rotation and guard rotation. Discuss the concept of pro-active versus re-active defence, including denial defence. Emphasise reading the offence.

DEFENSIVE TRANSITION:

Players must ALWAYS see the ball on transition. Teach defensive transition and how to defend against the fast break. Use breakdown drills to teach and practice. In covering the fast break teach responsibilities of first player back, second and third etc and teach to try to force the ball handler to change direction or pick up the dribble at the 3 point line. In covering the fast break teach players to spread the floor.

CRITERIA FOR THE DEFENCE TO BEAT THE OFFENCE:

- prevent penetration of the ball into the lane
- protect firstly against the player with the ball and the next most dangerous player
- force the ball toward the sideline or back out top
- play “lanes” and “stops” to create pressure

RULES FOR ALL DEFENCES:

- deny close passes
- shoot the gap on all cross court passes
- adjust position according to movement of the ball and the player
- make the adjustment while the ball is in the air
- always see the ball and your player

TEACHING THE CONCEPT AND PRINCIPLES OF OFFENCE WITH A SIMPLE MOTION OFFENCE

The following article on Teaching a simple Motion Offence uses the *Concept of Offence* and the *Principles of playing offence*. Once players have learned this concept and these principles they will be able to play any style of offence (provided they also learn the necessary skills for offence). Without this knowledge of the concept and the principles, a player will not be able to play team offence and will remain playing as an individual or a robot (relying on coaches instruction or other cues to play). A list of the principles for playing offence precedes the article on Teaching Motion Offence.

CONCEPTS AND PRINCIPLES OF TEAM OFFENCE

All players need to learn the concepts and principles of offence and defence. These principles apply to all types of offence and defence. With a good understanding of and an ability to play these, a player will be able to play all types of offences and defences. Without this understanding and ability a player becomes robotic or premeditates his actions.

There are 3 areas for a player to develop: *SKILLS; UNDERSTANDING HOW TO PLAY; and DECISION MAKING*. Of these 3 areas, the most important for a player to learn initially are understanding how to play and decision making. Skills take a much longer period to develop (approx 10 years to develop all skills to a high level), however they should obviously start to be introduced early in development to allow the player to have some competence and confidence in playing.

These concepts and principles apply to all court and field sports and all net sports.

OFFENCE

Concept

The concept of offence is: ***take the ball to open spaces***. Whether passing, dribbling or shooting, always take the ball into an open space, away from the defence.

Principles

Playing without the ball (a player spends most of the game playing without the ball and so what he does without the ball is most important).

- Always move away from your defence into an open space (be available for the ball)
- Use peripheral vision to see your defence, the ball and the court to make good decisions (the more you can see, the better can be your decision making)
- Move away from the ball, or away from an area, to create space for you, or a team mate, to move into
- Always turn (pivot) to see the court and the basket (never turn to see the outside of the court)
- Use change of direction to move into space (basketball is a game of angles). Create good passing angles by using a change of direction
- Use correct footwork to move and change direction. Point your foot where you want to move; step with your right foot to go right and with your left foot to go left (gives distance on the step and maintains balance)
- Use a quick first and second step to beat an opponent. Basketball is a game of beating an opponent with a one step in offence and defence. A quick first step and second step is more important than speed up and down the court
- Basketball is a movement game, not a game for statues. We move in 3 ways – walk, run and sprint. Walk and then explode is better than run, run, run (helps with timing also)
- Basketball is a running game – ie one foot on the floor at a time (in offence and defence). It is not a skipping, hopping, jumping, dancing game
- Always play with legs flexed (bent) to have immediate power available for movement. If you straighten your legs (stand up), you will need to bend them again to move – this makes you slow to react
- Play with your head in the middle of your body and keep it still. Do not swivel it from side to side to change your vision, instead open up your feet to see more
- Pivoting is used in almost every basketball skill
- Use good spacing (12-15 feet/4-5 metres apart) to spread the court (and the defence) to create space to move into

- Have good court balance (at least 2 players on each side of the court) to allow for good spacing and to be able to reverse the ball from side to side, and to allow for a safety player out top
- Keep it simple – basketball is a simple game, do the simple things that work. There are no points in basketball for “style”
- Teamwork is played by players without the ball. Communication is the key to all good teamwork. By leaving an area a player creates space for another player to come into (with or without using a screen). This creates movement of players and can be up and down the court (ie on one side of the court) or across the court (ie using the width of the court)

Playing with the ball

- Receiving the ball going away from the basket, square up taking the ball to the hip area of the free foot (the non pivot foot), ready to pass, dribble or shoot, in that order
- Receiving the ball going toward the basket, square up taking the ball to the shoulder of the free foot (the non pivot foot), ready to pass, shoot or dribble, in that order
- Always pass to a player who is moving (if he stops and the defence keeps moving, the defence will end up with the ball)
- Good passing teams are those that pass the ball to players in open spaces, not necessarily those that are technically correct
- Ball movement is important. The defence reacts (adjusts) to the movement of the ball first and player movement second
- Ball reversal is the single most potent weapon to beat good defence
- Manage the ball well (look after the ball) in crucial situations (at the end/beginning of a quarter and at the end of the game, or when the other team is applying pressure). The team with the less turnovers is usually that team that wins

The three steps to learning to play basketball.

There are 3 steps in teaching basketball to players and most coaches follow these same steps, however the sequence used here is different to that used by most coaches.

The emphasis of the 3 steps, in the order I use them, are:

1. Teach the concepts and principles of the game (the concept and principles of offence and the concept and principles of defence) and how to use them in playing.
2. Teach the players how to make good decisions during play by using their peripheral vision.
3. Teach the skills of the game of basketball progressively and in the correct order while learning how to play (step 1 above).

These three steps are used in teaching Motion Offence in this article. Firstly Motion Offence will be taught without any screens and secondly using screens.

Teaching the concept of offence.

The concept of offence is to take the ball to an open space, away from the defence and toward the basket (the scoring area). This concept is the same for all team sports and all net sports.

In basketball this means that in passing, dribbling or shooting the ball should always be taken to an open space away from the defence to execute these skills. In doing so the player is less likely to cause a turnover by easily giving up the ball to the defence and it also provides better opportunities to score.

Players should learn the concepts and principles of the game first, at the same time learning to use their peripheral vision to make good decisions. Players should develop the skills of offence as they develop their knowledge of how to play and how to make good decisions. This allows them to be able to play immediately and importantly helps them to develop their natural talents. In addition, as the player learns to play within the concepts and principles of the game he will also learn to read what is happening and make good decisions of what to do.

The following steps will allow the coach to teach **Motion Offence without screens** by using the first two steps listed above (teaching the concepts and principles of the game and teaching the player to make good decisions).

DRILL 1

2 on 2 quarter court
(no dribble, no scoring)

TEACHING POINTS AND EMPHASIS

The player without the ball moves to open spaces, always moving away from the defence by focusing mostly on the defensive player. The players must play within the allowed court space, that is the quarter court. Emphasise using peripheral vision to see both the defensive player and the ball. Check whether the player without the ball is focusing on the ball, instead of on his defensive player, as he should be. Correct the player when he moves toward the defence and does not move to space away from his man. This is done by the player moving and changing direction away from where the defensive player is going.

Assist the player to read his defence and to change direction to get between the ball and his defence to be in an open space to receive the ball. Seeing the ball, his defence and the defence on the ball will allow the player to make good decisions of where to move to. Emphasise to the player to run, not skip, jump, hop or dance. Basketball is a running game. When the player with the ball makes a pass, he then moves away from his defence into an open space and the drill continues in this way (the defence should make every effort to prevent their man from receiving the ball).

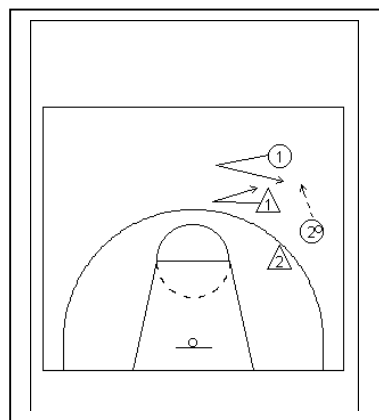
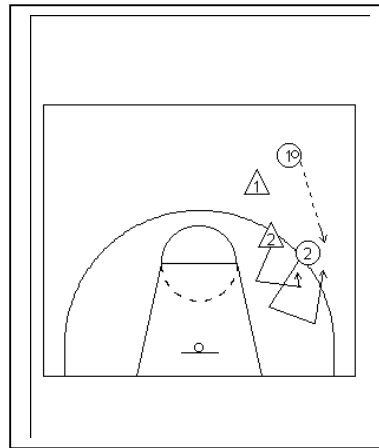

DRILL 2

2 on 2 quarter court (no dribble, no scoring)

TEACHING POINTS AND EMPHASIS

Continue by adding the teaching points of using all the available space to get open and having the player without the ball make good choices as to which of the available spaces he should run into.

Stress moving away from the ball creates more space into which to move (running toward the ball reduces the amount of open space). Teach the correct footwork of pointing the foot where the player wants to go and step with the left foot to go left and the right foot to go right. Teach the player to pivot on the leading foot and to step with the other foot to change direction. Basketball is a game of angles and requires change of direction. Do not allow the players to run in the same straight line back and forth or to run in circles. Have them try to beat the defence with one step and a change of direction, trying to get between the defence and the ball when defended closely.

Add moving with the hands up to protect the space around the player's body and to be ready to catch the ball. Add squaring up to the basket in the correct way (always pivoting to see the court and the other players, never turning their back to the court). Teach passing angles between the player without the ball and his defence and the player without the ball and the ball handler's defence. Teach the player that by changing direction when moving away from his defence he will

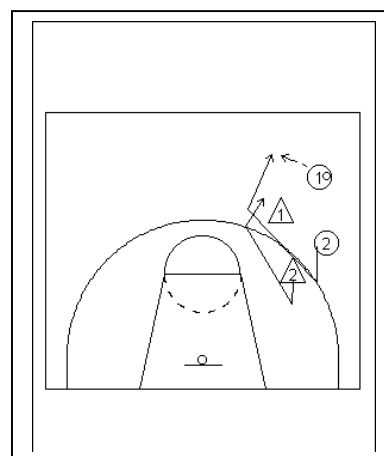

improve the passing angle and so have more space to safely receive the ball. Demonstrate and correct this as many times as necessary to have the players understand. Stress to the player with the ball to have some patience before passing the ball. This means making sure the receiver is in a space away from his defence, that he is moving (never pass to a player standing still – except in the low post position) and at a good passing angle. The player without the ball needs to continue to move until he has a good passing angle and until the ball hits his hands. He must not stand still to catch the ball (if he does the defence may keep moving and get the ball). Point out to the players that 2 players usually play up and down the court not across the court and so by using a quarter of the court this is more realistic in relation to the game.

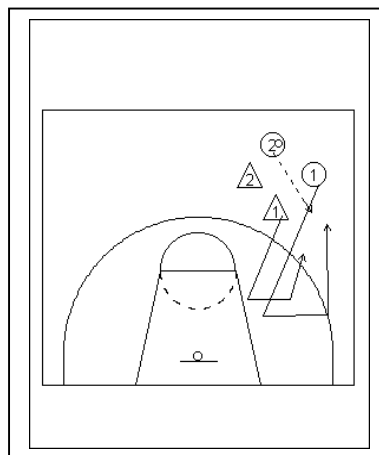

DRILL 3

2 on 2 quarter court (no dribble, add scoring)

TEACHING POINTS AND EMPHASIS

Continue and allow the players to score, but only from within the key (lane) and only from below the jump ball circle – encouraging a lay-up. Continue to emphasise reading the defence by the player without the ball and also the reading of all the players by the player with the ball and making good decisions (the passer has to see his team mate and his defence and also his own defensive player). Now by adding scoring the player without the ball is trying to get open going toward the basket, as much as possible.

Teach players to pass and cut, where possible between their defence and the ball, to have opportunity to score (pass and cut/give and go skill). Also emphasise the use of space to create a backdoor cut to the basket. By the correct use of space and reading of the defence to always move away and by using changes of direction the player without the ball should be able to get a scoring opportunity in the lane on most occasions. Teach patience in trying to get a good scoring opportunity. Continue to emphasise using all of the available court area and correct footwork.

DRILL 4

3 on 3 half court (across the court
- no dribble, no scoring)

TEACHING POINTS AND EMPHASIS

Now with more offensive (and defensive players) on the court, stress that it is important to have vision on all players to make good decisions. The players now learn to play in positions and maintain spacing and court balance. The three positions used are the guard position (level with the elbow of the lane and halfway between the 3 point line and the centre line) and the two wing positions on each side of the court (above the free throw line and outside the 3 point line).

Later when the players understand about spacing and playing to position and reading the game better they may play in other positions. But initially these three positions will allow them to have good angles to be able to get the ball to players going toward basket. By learning to play in positions on the court the players will start to understand about maintaining court balance and spacing. This means always having a player on each side of the court and not having two players run to the same space (have them play 15 to 18 feet, or 3 to 5 metres, apart). Have the players

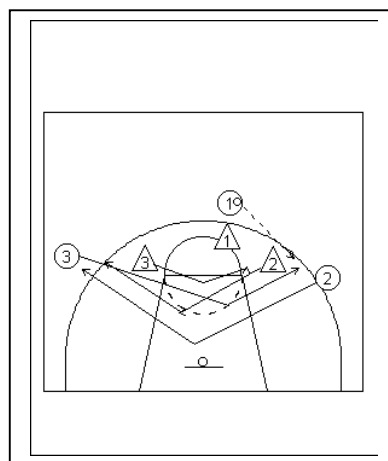

without the ball move to get open within their area of the court (do not let them run just anywhere) by reading the defence and moving to spaces away from their defence and using changes of direction (V-cuts).

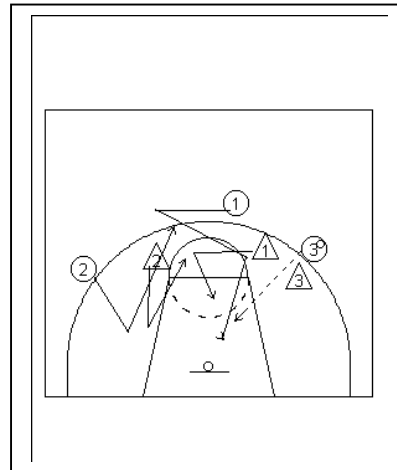

DRILL 5

3 on 3 half court (across the court
- no dribble, no scoring)

TEACHING POINTS AND EMPHASIS

Now we start to teach teamwork between the players playing without the ball (the ball should start in the guard position). By working together across the court each of the players without the ball will have more space into which to beat his defence. This makes it easier to beat the defence (more space to play in). Teamwork starts with communication (that is one player needs to call the name of the other player and then initiate a movement). This movement should be toward the basket, and as the player leaves his side of the court he creates space for his team mate to run into (this player should also use angles of movement). Now that his team mate has moved from the other side of the court, the player that initiated the teamwork has space into which to beat his defence (when flaring it wide use sharp angles of movement). Of course by reading the defence and using all of the available space it maybe possible to take the defence out wide and then beat him again on a backdoor cut or using a curl cut to move back to the basket between the defence and the ball. The players without the ball should be looking for all ways to beat their defence to a space to receive the ball, even if there is no scoring allowed. Once a player has communicated with his team mate and then initiated a movement he may change this movement by communicating again quickly with his team mate. This means that on an initial movement the player reads his defence out of a good defensive position and now moves back toward where he came from or to another part of that side of the court to be in a space to receive the ball. Without this re-communication both players we would not maintain good court balance as both players without the ball would end up on the same side of the court. When a player passes the ball he should always cut to the basket, creating a possible scoring opportunity. The other player without the ball will then exchange with this cutter, filling the space he left by using angles of movement. Again good, clear

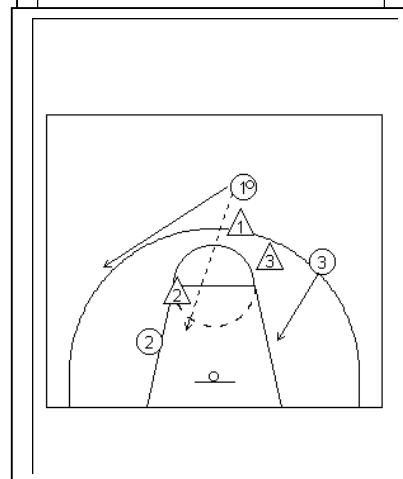
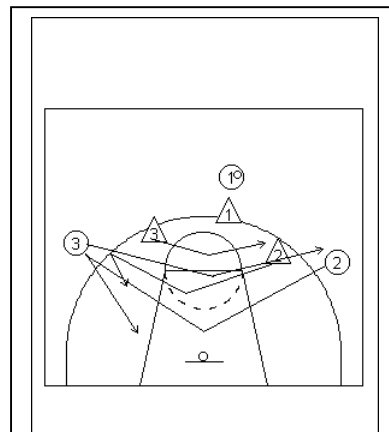

communication is the key. Now the players learn that by a player leaving a space he will create space for the other player to run into. The player with the ball needs to see both offensive team mates and their defence to get the ball to the first player who is open in a space away from his defence. In order to see all of the court the player with the ball should look toward the basket and use peripheral vision to see the other players. He may then sharp focus momentarily to make a pass.

Players without the ball need to continue to read their defence and move to spaces away from the defensive player and NOT run to spots on the floor. With some pressure from the coach the players will start to move

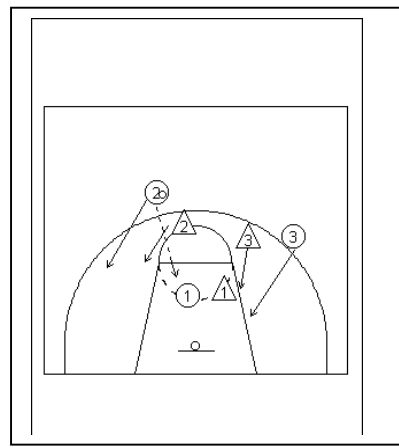
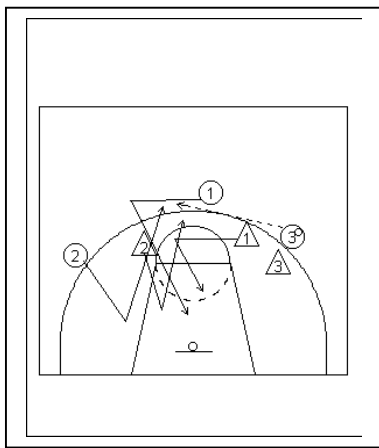
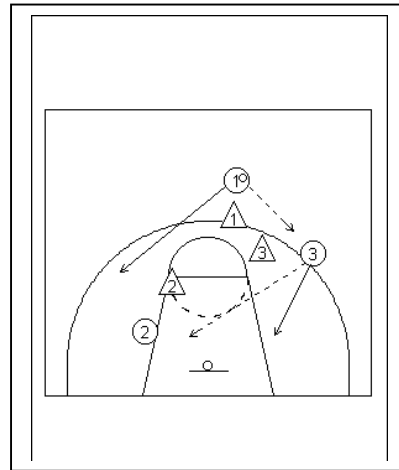

quickly and at the same time be able to read the defence to move to spaces where they are open (creating opportunities to beat the defence – for scoring later). Have the players use changes of movement (ie walk and then explode) to beat their defence to a space. Stress getting open going to the basket as well as flaring out wide. Do not let the players continually be passing the ball away from the direction of the basket. Teach them to always be looking to score with a pass and if they do not get open inside the key (lane) then they must move out to space to be available for a pass (later for ball reversal).

DRILL 6

3 on 3 half court (across the court - no dribble, add scoring)

TEACHING POINTS AND EMPHASIS

Quickly build to scoring, again within the lane and below the circle to encourage a lay-up. Ensure that the shooter shoots the ball ONLY in an open space. If his defence, or another defensive player, gets to him then he looks to make a pass. The player who passes to him should be cutting toward the basket and an open space (reading his defence by cutting out of the vision of his defence) for a pass or a rebound. Continue to stress passing angles, reading the defence and reading of all players by the passer along with maintaining patience to get the best pass. From this drill the players are learning that they should play on the outside and try to score on the inside (creating movement of players and the ball on the outside and leaving the lane open and free to move into to score easily). In all shooting situations there should be a shooter and a rebounder. The third player must fill toward the guard area at the top of the key (lane) to be available for a pass outside and be in a position ready to play defence on a turnover (this is called the safety position).

DRILL 7

3 on 3 half court (across the court - add dribble, scoring)

TEACHING POINTS AND EMPHASIS

The concept for using a dribble is the same, *always take the ball to an open space* and toward the basket (where possible). Emphasise that there are only two reasons to use a dribble – to penetrate the ball toward the basket or to improve a passing angle (includes using a retreat dribble). Do not allow players to dribble the ball up and down on a spot or to dribble in circles (have them use a dribble to take the ball somewhere, that is by pushing the ball forward/out). Scoring should again be within the lane but now a pull up jump shot is allowed as well as a lay-up. Emphasise that the shooter must shoot the ball in a space, not take the ball to the defence. Ensure that the players without the ball read all the other players on the court and maintain good court balance and spacing. Ensure that they make good decisions as to which space to move into by reading their own defensive player (especially when he goes to help on the ball handler) to be available for a pass (stress passing angles).

DRILL 8

3 on 3 half court (across the court - scoring with dribble)

TEACHING POINTS AND EMPHASIS

Now we teach the use of a dribble entry and a shallow cut. This play can be used in the game when the defence denies a pass into the wing position to initiate the offensive movement. The guard dribbles toward the wing position. This forces the wing player to make a cut away from that area (creating space for the dribbler to move into) toward the basket and then he moves sharply back up toward the guard spot. If from the free throw line out, his defence is ahead of the line between him and the ball he should make a backdoor cut to the basket (move to the open space away from the defence). The player making the shallow cut may also work in teamwork with the other wing player. Good communication will assist this. Stress to the players to be patient and to not rush. A mixture of slower movement and explosive movement will get them open easier. Ensure that the player with the ball has good vision to see all players and makes good decisions about where to take the ball (do not rush passes).

As a guide the coach will probably have taken about two hours to get to this point on the initial session of introducing the concept and principles of offence and start to teach Motion Offence without screens. For the coach of a beginner team this session should be repeated again, preferably with a skill session on dribbling and shooting in between (should the coach be fortunate to have 3 practice sessions a week). If there are only two sessions available in a week then the first session in the next week should be on skills, followed by another session on the teachings to this point. For the coach of a more advanced team of players then the progression can build from session to session. For such players some steps may be eliminated in the progression and the whole offence may be delivered initially in a two hour session. Of course practice for future sessions will require breakdown drills of the various steps, building up to the whole offence. This applies to all levels of players.

DRILL 9

3 on 3 quarter court
(use of triangle, scoring, no dribble)

TEACHING POINTS AND EMPHASIS

When the players were playing 3 on 3 half court they were playing across the court. In a 5 man offence players have to play both across the court and up and down the court (that is on one side of the court). The players at the beginning in playing 2 on 2 were playing up and down the court. In a 5 man offence there could be 3 players playing up and down the court on one side and 2 players playing up and down the court on the other side. In this way the 5 man offence would maintain court balance and spacing. Again the players will learn through this drill to play in positions. The three positions used are the guard position and wing position (outlined earlier) and the low post position. This position is on the side of the key (lane) and just above the neutral zone (also called the block). If the low post player plays below this area (that is

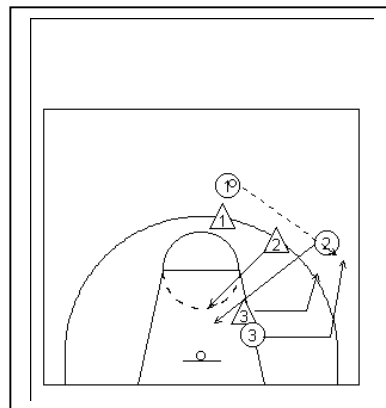

closer to the baseline) then he will not have a good angle to the basket on any baseline move. By playing in these three positions the players are creating a triangle. They could create a triangle by playing in other positions but to initially learn how to play in a triangle these positions provide for the easiest passing angles and scoring opportunities. Again we should start with the ball in the guard position.

The other two players (wing and low post) now play together as before in 3 on 3 across the court. Since we preferably want to get a player open going toward the basket it must be the low post player who communicates and initiates the movement and leaves his area first, to create space for the other player to cut into. The low post may move up the lane toward the free-throw line, allowing space for the wing to cut baseline side. This may result in a pass to the player filling the wing position and then a pass inside to the new low post player (later also for ball reversal to the player moving toward the basket). Or the low post player may move out toward the sideline and move sharply up toward the wing position, allowing the wing to cut into the middle of the lane. This may result in a pass to the wing from the guard if the wing can cut ball side of his defence, or a pass to the player filling the wing and a ball reversal pass inside to the player cutting toward the basket. These movements by the wing and the low post players will be the basis of setting good screens later on, as well as providing opportunities for immediate scoring now without screens. Should the ball be passed by the guard to the player filling the wing position and there is no pass available to the player cutting to the low post position, the low post and the guard will now play together.

Again the low post player will communicate and initiate the movement to allow space for the player cutting to the basket. It is important that the low post player gets to the free-throw line before the guard enters into the lane. To set some timing the guard must walk his defence across the court (not toward the free-throw line) and away from the ball for a few steps to see if he can create space to cut between his defence and the ball. This will allow time for the low post to have vacated his area and create more space for the guard to cut into (move away from an area to create space to cut into). If this timing is not there then the guard will arrive into the low post area while it is still being filled by his team mate and his defence. Now any pass is a possible turnover as it will not be to a player in space. The players can continue to play in this way. Again the coach should stress not to rush and to use patience and timing to try to get a score in the lane on the way to the basket.

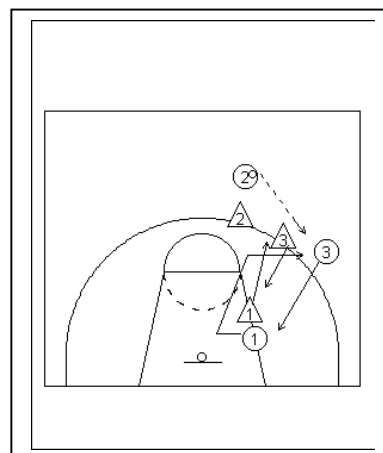
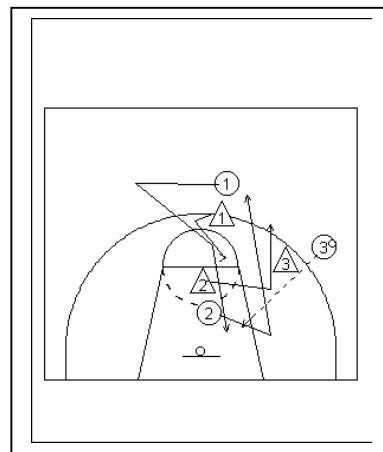
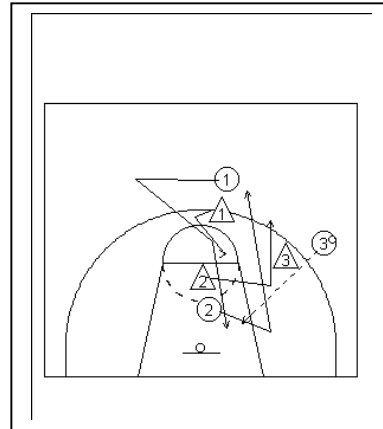

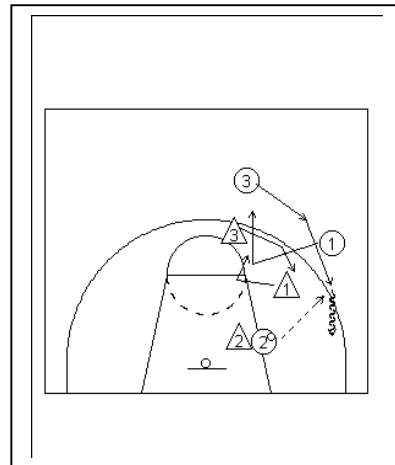
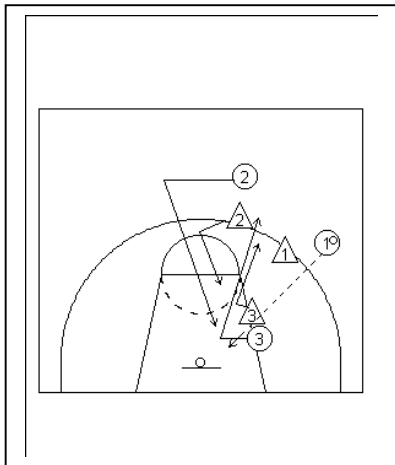

DRILL 10

3 on 3 quarter court (add post play in triangles)

TEACHING POINTS AND EMPHASIS

Now the coach needs to teach the players how to play in the post. Simple back to the basket moves should be taught first, followed by front to the basket moves. Players should also be taught how to feed the pass correctly to the post player with a curl pass and off the dribble. Once post offence has been taught the players can post up while running a triangle offence. Now the post player will be a bigger threat in the play (he must always read his player and only make a move with the ball if the ball is being taken to an open space). Outside shooting can also be added from a pass out from the low post (ie an inside/outside game) but always within shooting range of the player. The two perimeter players should still look to move and exchange by creating space for each other and reading their defence. Communication is still the key to good teamwork.

DRILL 11

4 on 3 quarter court (add ball reversal)

TEACHING POINTS AND EMPHASIS

The next step is to teach ball reversal to the other side of the court to be able to take the ball to the player in an open space on the opposite side of a well positioned defensive player. Ball reversal is an excellent way to beat good defence. In addition to the three players in the triangle we now have a passer positioned in the wing spot on the other side of the court (the player should initially be in closer to the lane than would be normal in a game to ensure easier passes). Make sure that the ball is only passed to the passer when the player with the ball sees that one of his team mates is going to be open from the opposite side of the court. Now the player with the ball is required to read all the play and see opportunities coming up before they actually are available (reading the play). The opportunities could be one of the following play situations. When the ball is with the guard and the wing makes a baseline cut, if the wing and his defence and the ball are in a line as the wing crosses inside the 3 point line then the guard reverses the ball to the passer for a backdoor play with the wing. If the wing cuts between his defence and the ball the guard can reverse the ball to

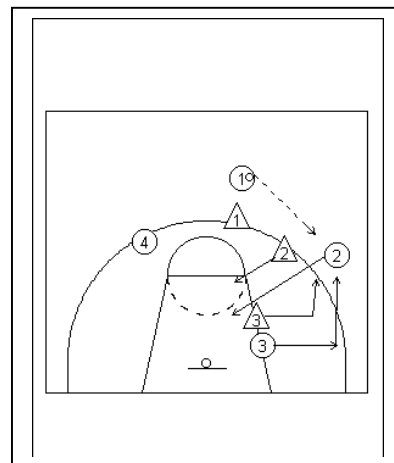

the passer for a better angle pass to the wing. When the ball is with the wing and the low post player is forced to cut up high with his defence between him and the ball the wing can reverse the ball to the passer for a pass to the low post player dropping back to the basket. If the guard is forced to cut toward the basket with his defence between him and the ball the wing can reverse the ball to the passer for a pass to the guard cutting to the basket. Wherever the ball may be, anytime the low post player spins and pins his defence on the side opposite the ball the ball should be reversed to the passer for a pass into the post. Early vision and decisions are essential to create the timing for these ball reversal situations and it may take some time for the players to get the decisions and timing correct. Do not allow the player with the ball to reverse it to the opposite side of the court unless he can see an opportunity to get the ball to a player going to the basket and to beat good defence.

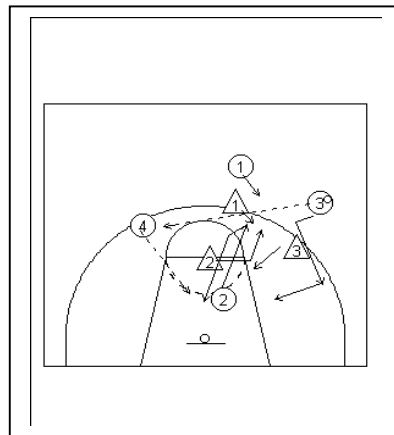
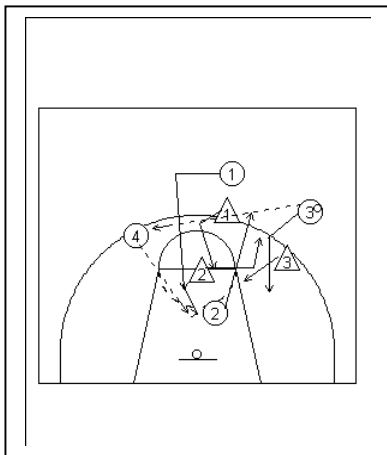
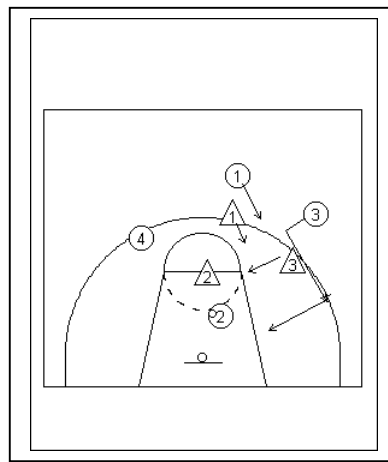
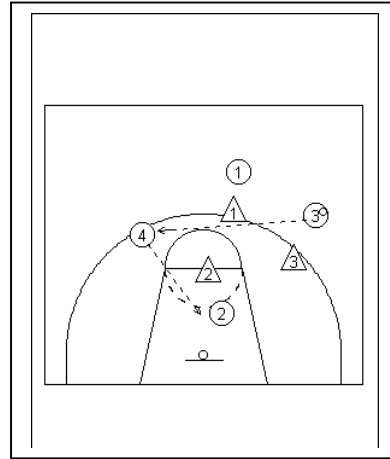

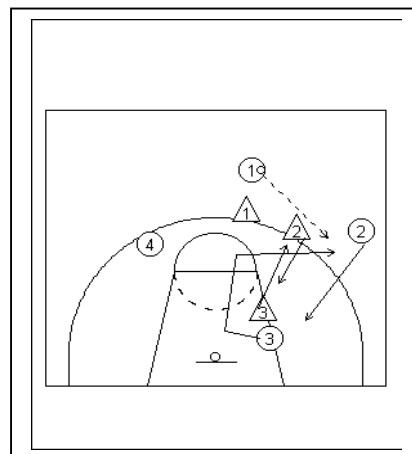
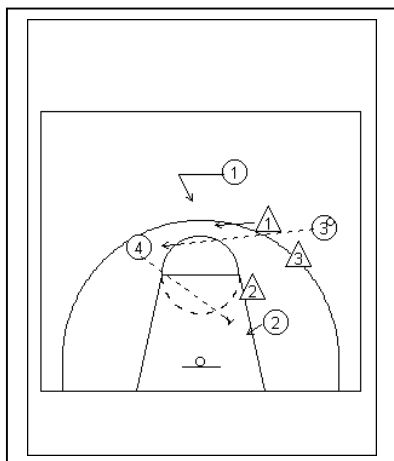

DRILL 12

4 on 4 half court (playing up and down the court on the perimeter)

TEACHING POINTS AND EMPHASIS

The players now play two on each side of the court, in the wing spot and the guard spot (that is there are two players on each side of the court playing up and down the court). By playing 4 out the players learn to play together on the perimeter of the offence.

The two players on the side opposite the ball work together (exchange with each other) looking to get open by creating space for each other. The movement may be initiated from the guard or the wing. The guard may make a cut to the basket allowing the wing to flash up. Or the wing may make a baseline cut (similar to a shallow cut) allowing the wing to flare wide (a possible 3 point play or baseline drive play).

The player without the ball on the ball side must learn to get open within his own area. The player with the ball must see all his team mates and their defence to make a good decision. He must pass the ball to the first player open, making sure that the ball is reversed from side to side as much as possible (always looking to reverse the ball to beat good defence, not just moving the ball from one side of the court to the other).. Ensure that the players maintain good spacing on each side of the court and stay on their side (do not let them change across the court to the other side).

Stress having patience (hold the ball and look before passing – do not just throw the ball around the court). Add scoring with one dribble to a lay-up allowed (no other shot is allowed).

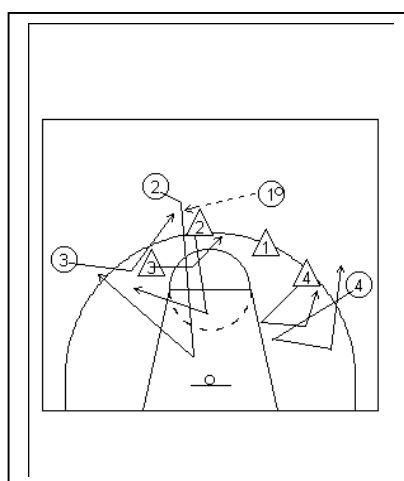

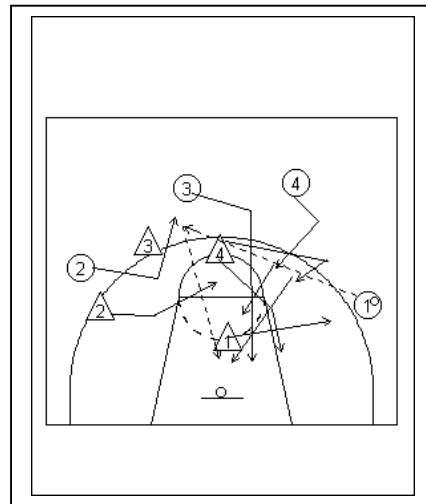
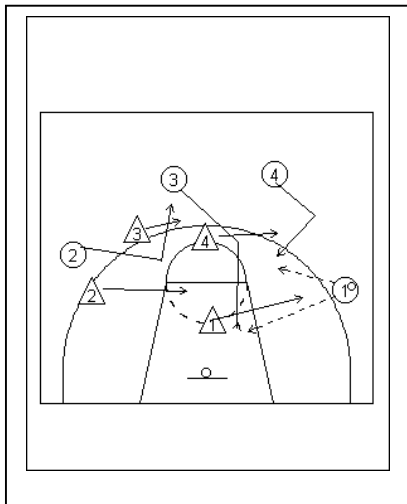
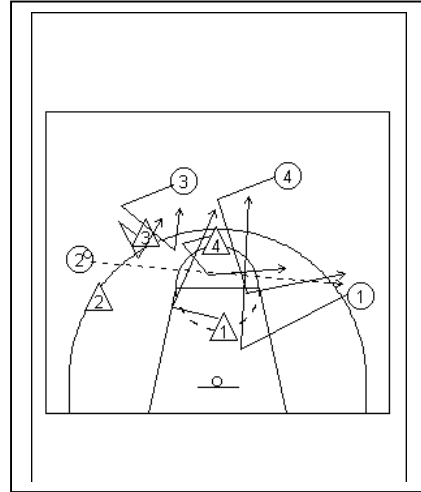
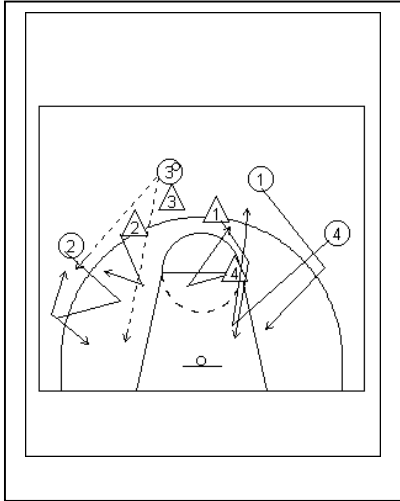

DRILL 13

4 on 4 half court (playing up and down and across the court on the perimeter)

TEACHING POINTS AND EMPHASIS

Continue to play two on each side of the court, in the wing spot and the guard spot, playing together up and down the court to get open. Add that a player without the ball may also communicate with a team mate on the other side of the court to play with him now playing across the court as well). This extra movement will require much more patience and timing and the coach must stress not to rush. When the player without the ball on the ball side crosses the court to play with another player he then sets up a clear out situation for the player with the ball to play one on one on that side. Players should be allowed to use a dribble for penetration and creating a passing angle. Continue to stress reading the defence to make good decisions.

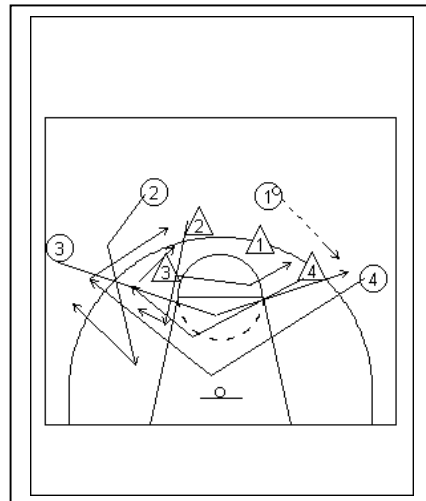

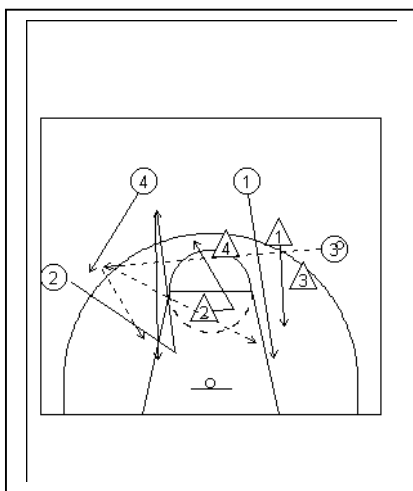
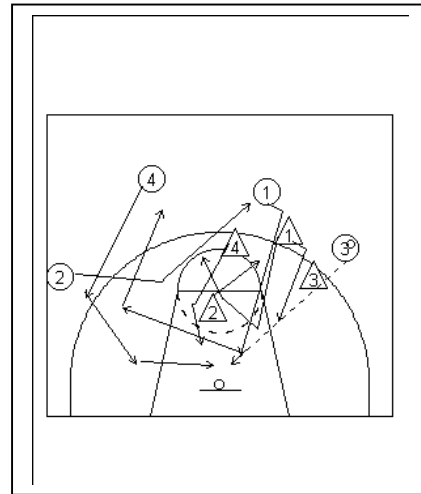
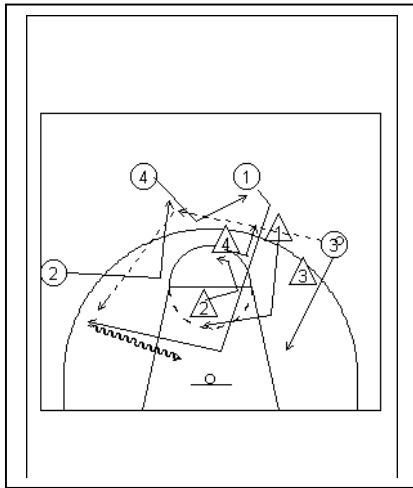

DRILL 14

5 on 5 half court (basic Motion Offense without screens)

TEACHING POINTS AND EMPHASIS

Now put the lot together. Three players in a triangle on one side and two players in the guard and wing spot on the other side. The player with the ball continues to look for the first open player. Allow the players to dribble and score inside. Stress leaving the scoring area (the lane) open, maintaining good spacing, having patience to score and also using ball reversal to beat good defence. When the ball is reversed and the lane is not being entered by a team mate the low post player should change sides to form a triangle on the other side of the court. Teach the low post to turn and face the lane before cutting to ensure that he can read the defence and move to space and so as not to interfere with any cutter into the lane. If the ball is reversed and the wing and low post player are in the process of exchanging then the wing should continue to the other side of the lane to fill the low post position. Later the coach can add that this wing may also communicate with the other wing and exchange with him (ie playing across the court from the perimeter).

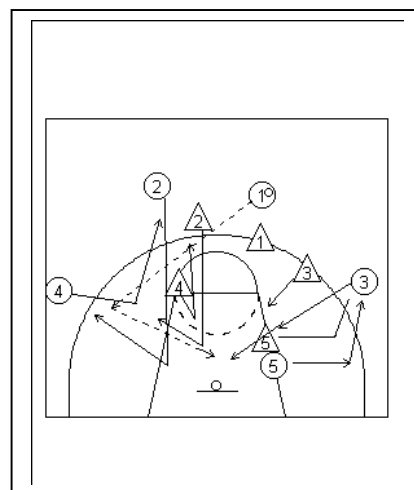

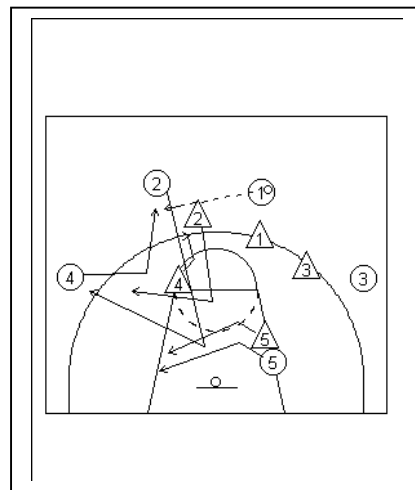
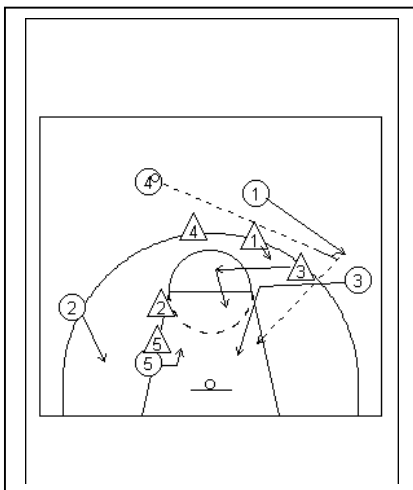
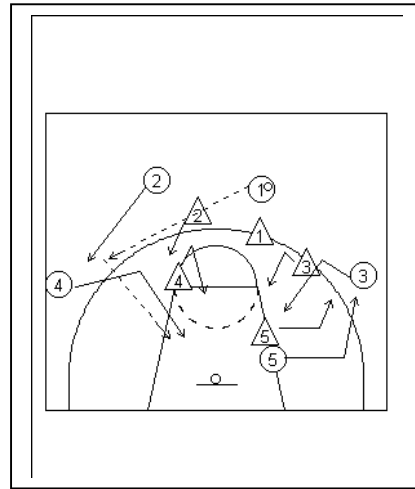
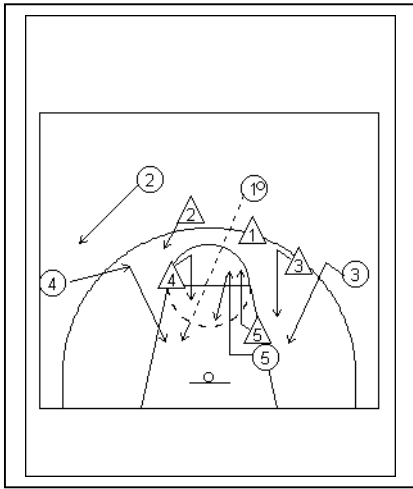

As the coach continues to teach the offence through breakdown drills in practice sessions he should not simply have the players start from a standing start from the guard position. The guard should be made to dribble the ball across the centre line into the front court with the other players already moving to get open. This simulates more of how the offence may be initiated in a game situation. Too many coaches allow players to practice from a standing start and consequently they do this in a game. This only allows a good defence to step up and deny passing lanes, taking away any early chance to score and reducing the time available on the 24 second clock in which to create a good scoring opportunity.

Once the players have learned how to play with the concepts and principles of offence through the Motion Offence without screens in chapter one his and can execute with reasonable ability then the coach can teach **Motion Offence with screens**. If the coach was to try to teach Motion with screens before the players understand the concepts and principles outlined in chapter one then play will most likely be static and will gravitate toward the lane, at the same time the opportunity for learning good decision making will be limited.

Teaching screening.

The following rules may be used to teach screening. The first three rules are for the cutter, the player using the screen. In using the screen the cutter must always move close to the screen as he passes the screen ("brush" shoulders with the player setting the screen) to stop the defensive player

getting through with him. Before using the screen **the cutter's first movement should always be away from the screener** in order to set up the defence or to read the defence and move away from him into space (the cutter may not need to use the screen if he reads his defence correctly). Screens set against stationary defence will usually not be successful as screens set for a moving defence.

RULES FOR THE CUTTER:

1. If the cutter's defence follows (or tries to follow) him around the screen then he must cut to the basket (using a curl cut).
2. If the defence goes behind the screen then the cutter steps (flares) out to the ball.
3. If the defence steps over the screen early to stay with the cutter then the cutter fakes in that direction and then makes a backdoor cut on the opposite side of the screen.

Players should also understand that these rules follow **the concept of offence** – always moving to an open space way from the defence (that is go to the opposite side of the screen to where the defensive player goes).

The next set of rules is used for teaching the screener (the player setting the screen). The screener should always set his screen with his back towards the ball. One way to get the best angle for the cutter (who wants to be able to go to the basket if at all possible) is to have the screener always make a cut to the basket before trying to set the screen. Some coaches teach the screener to go to the defensive player to get close to make sure that contact will occur. I believe that in Motion Offence it is better for the screener to set his screen away from the cutter and allow the cutter to work his defensive man into the screen. This allows space for the cutter to beat his man, with or without the use of the screen. Now the cutter is able to make decisions based on what his defensive players allows.

RULES FOR THE SCREENER:

1. If the cutter goes to the basket, open and go to the ball.
2. If the cutter goes to the ball, open and go to the basket.

Some coaches allow the screener to open in whatever way he desires. I insist that the screener open in the same way every time, the reasons for which I shall explain later. I have the screener ALWAYS open by pivoting to see the cutter first and then see the ball. In order that this can be executed correctly it is important to teach the screener that as the cutter comes by the screen he should pivot on the foot furthest from the cutter to turn and face first the direction the cutter has moved in (to see the cutter) and then to see the ball. In this way the screener will have the cutter's defence on his back and be open to the ball. This is important should the defence switch on the use of the screen. It also allows for easy spitting of the defence, opening for ball reversal and re-screening (setting a screen again for the cutter). It is important to teach players to communicate in the game. In setting a screen for another player, the screener needs to call out the name of the player he is setting the screen for early (that is before he even moves in the position to set the screen). This allows the cutter to set up his man. If a player hears his name call and when he looks to that player calling his name, the player does not have the ball he knows that the player is going to set a screen got him. If the player has the ball he would know that player wanted him to get open to pass to him.

It is important that players understand that when defences switch to defend a screening situation, they do so to defend the cutter. Now the screener is usually the player that is open to receive the ball. Therefore coaches should have their better scorers set the screen, rather than be the cutter. Also the use of re-screening will allow a scorer who has cut off a screen to get open from the screener position in a switching defence.

I believe that until players are able to execute well screens for players away from the ball that they should not be allowed to set screens on the ball. When the players have mastered screening off the ball and on-ball screens are taught the players should follow the same rules for cutter and screener. Some coaches teach only screen and roll principles for an on-ball screen. In reality screen and roll rules are simply the same as the rules outlined above for cutter and screener. A screen and roll (to the basket) may

be what is required in a particular situation, however in others the screener may be required to flare out to another space. Teach players to make good decisions based on what they see and perceive.

There are four types of screens (a screen is sometimes also called a pick) that players need to learn – a back screen, a flare screen, a down screen and a cross screen. The back and flare screens are used in conjunction with the post player (either low post or high post). The following describes each screen and its use.

1. Back screen – the post player steps out with one big step and sets a screen for the wing player (or in the case of a high post for the guard).
2. Flare screen – the wing (or guard in the case of the high post) moves toward the post player with two steps and sets a screen for the post player to move out.
3. Down screen – a player sets a screen for a player below him on the court (below means toward the end line of the opponents basket, also called down the court).
4. A cross screen is used by low post players, usually when there is one on each side of the lane.

The following drills are used to teach Motion Offence with screens and are the same drills as in the previous section on Motion Offence without screens (refer to that section if in doubt of all teaching points). In adding screens the only major difference is that instead of the two players simply “exchanging” positions, one sets a screen for the other. Timing remains an important component of all screening offences.

DRILL 15

3 on 3 quarter court (no dribble, no scoring)

TEACHING POINTS AND EMPHASIS

The same three positions of guard, wing and low post are used. Now the low post may set a back screen for the wing or for the guard, the wing may set a flare screen for the low post and the guard can set a down screen for the low post or for the wing. Players need to use more patience and timing to set their defensive man up when using the screen. Also reading their defence and going to the open space remains the essence of movement without the ball. The players continue to learn that by a player leaving a space he will create space for the other player to run into. The player with the ball needs to see both the cutter and the screener and get the ball to the first player who is open in a space away from his defence. Initially only allow the players to use screens and later they can be allowed to play without using the screen if the defensive player cheats on the screen. Continue to emphasise to read their defence and move to spaces away from the defensive player and NOT run to spots on the floor.

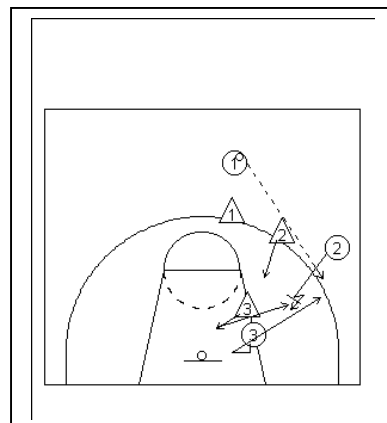
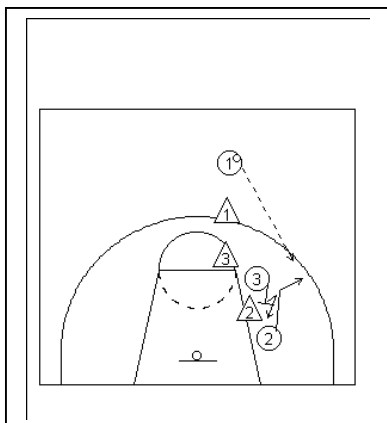
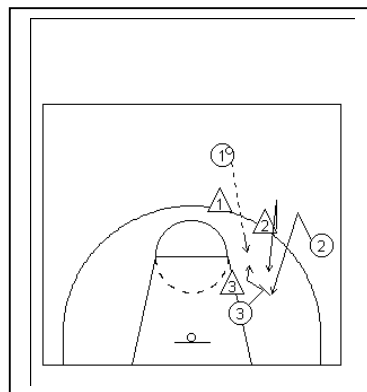

DRILL 16

3 on 3 quarter court (no dribble, add scoring)

TEACHING POINTS AND EMPHASIS

Quickly build to scoring, again within the lane and below the circle to encourage a lay-up or pull up jump shot. With the limitation of where the shot may be taken it encourages back screens for scoring. The other two screens should still be used to get players open. Ensure that the shooter ONLY shoots the ball in an open space. If his defence, or another defensive player gets to him then he looks to make a pass. The player who is most likely to be open in the case of two defenders on the ball will be the screener. Continue to stress passing angles, reading the defence and reading of all players by the passer along with maintaining patience to get the best pass. Again from this drill the players are learning that they should play on the outside and try to score on the inside (creating movement of players and the ball on the outside and leaving the lane open and free to move into to score easily). Ensure that the players maintain good spacing and do not gravitate toward the lane to play.

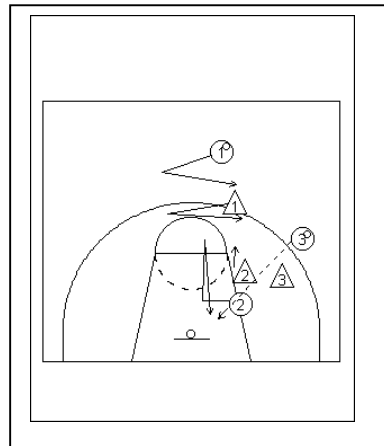

DRILL 17

3 on 3 quarter court (add dribble, scoring)

TEACHING POINTS AND EMPHASIS

Now post moves can be added and the inside/outside game learned. A general rule used by many coaches in Motion Offence is that a perimeter player without the ball should always screen for a player below him on the same side of the court. To teach this, a pass to the low post will require a down screen by the guard for the wing (this adds to the teaching of the inside/outside game and relocation). Continue to emphasise that there are only two reasons to use a dribble – to penetrate the ball toward the basket or to improve a passing angle. Do not allow players to dribble the ball up and down on a spot or to dribble in circles (have them use a dribble to take the ball somewhere). Scoring may now be from anywhere within shooting range (stress good shot selection). Emphasise that the shooter must shoot the ball in a space, not take the ball to the defence. Ensure that the players without the ball always see the ball. Have them read all the other players on the court and maintain good court balance and spacing. Ensure players use good decision making as to which space to move into by reading their own defensive player (especially when he goes to help on the ball handler or switches of defence – if this is what you want to allow).

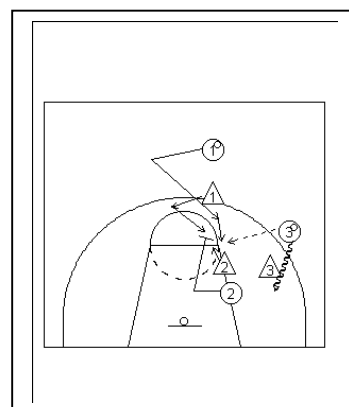
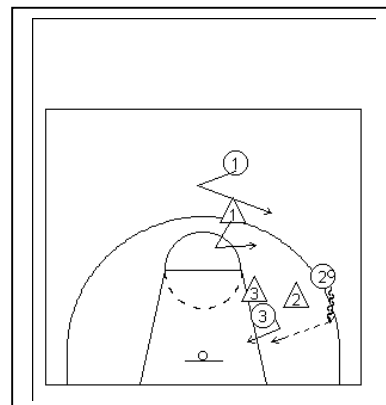

DRILL 18

3 on 3 quarter court (with dribble and scoring)

TEACHING POINTS AND EMPHASIS

Now players can use a dribble entry and a shallow cut as well as screens. The guard should read the defence and if the pass to the wing is denied then use the dribble entry. On the shallow cut the wing player may cut below the low post and use a screen set by him or simply cut above the low post area. One of the problems in having the low post set a screen for the wing making a shallow cut is that we have too many players in a close area of the court (and mostly in the corner). Being able to create spacing quickly is a problem, however creating this situation would be OK for advanced level players.

DRILL 19

4 on 3 quarter court (add ball reversal)

TEACHING POINTS AND EMPHASIS

Ball reversal is added. Players in the wing guard positions on each side of the court use down screens to get players open. This opens up many opportunities with screening, especially for the screener. Continue to read the defence.

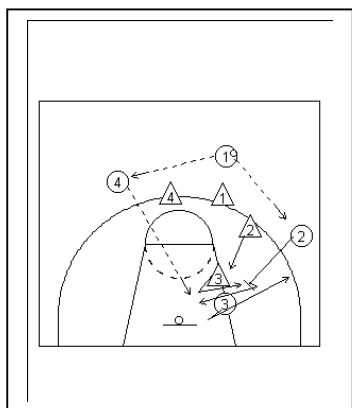
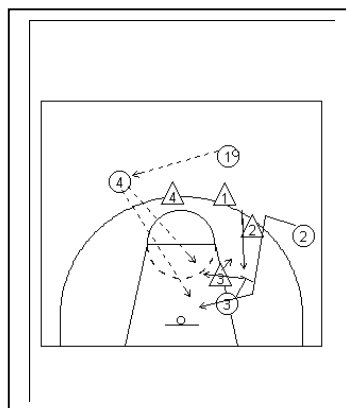

DRILL 20

3 on 3 quarter court (play in triangles)

TEACHING POINTS AND EMPHASIS

The coach can now just let the players play in triangles and let them learn how to read the defence, develop spacing, patience and timing and encourage all players to be a threat in the in the low post position.

DRILL 21

4 on 4 half court (playing up and down the court on the perimeter)

TEACHING POINTS AND EMPHASIS

Now the player will use down screens on each side of the court. They continue to look for scoring opportunities on all parts of the court. They are perimeter players in these positions and must learn to play outside and score inside. Add scoring with one dribble to a lay-up allowed (no other shot is allowed).

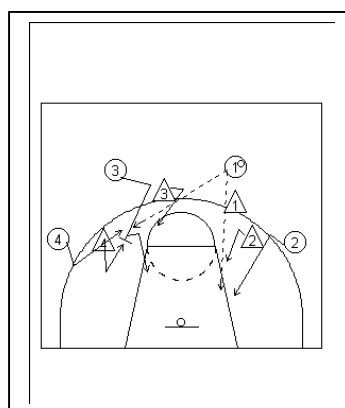

DRILL 22

4 on 4 half court (playing up and down and across the court on the perimeter)

TEACHING POINTS AND EMPHASIS

Continue to play two on each side of the court, in the wing spot and the guard spot, setting down screens or playing by oneself in an area to get open. Add that a player without the ball may also communicate with a team mate on the other side of the court to play with him. In crossing the court the player will set a back screen for the wing or guard (whoever he is playing with). When the player without the ball on the ball side crosses the court to play with another player he then sets up a clear out situation for the player with the ball to play one on one on that side.

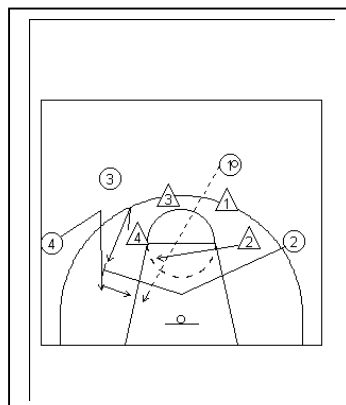

DRILL 23

5 on 5 half court (Motion Offence with screens)

TEACHING POINTS AND EMPHASIS

Now put the lot together. Three players in a triangle on one side and two players in the guard and wing spot on the other side. The player with the ball continues to look for the first open player. Allow the dribble and scoring inside. Stress leaving the scoring area (the lane) open, maintaining good spacing, having patience to score and also using ball reversal to beat good defence. The low post player can change sides on ball reversal provide a team mate is not going to enter the lane. Have the post player always turn and face the lane before cutting so that he read his defence and move to the best space available. In addition he can then see that the lane is open for him to cut across.

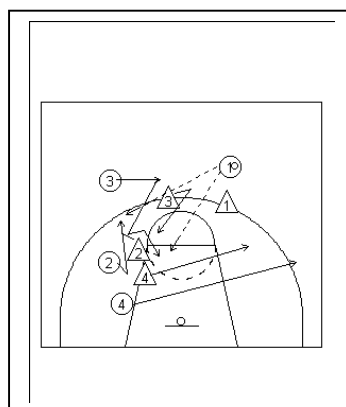

I remind coaches, as they continue to teach the offence through breakdown drills in practice sessions to not have the players start from a standing start from the guard position. The guard should be made to dribble the ball across the centre line into the front court with the other players already moving to get open. This simulates more of how the offence may be initiated in a game situation. Too many coaches allow players to practice from a standing start and consequently they do this in a game. This only allows a good defence to step up and deny passing lanes, taking away any early chance to score and reducing the time available on the 24 second clock in which to create a good scoring opportunity.

Additional notes: The set up used in the demonstrations has been a 4 out, 1 in offence (that is 4 perimeter players and one post player inside). Later other set ups may be used, such as a 3 out, 2 in offence. I prefer to use only one post initially as it helps players to understand that the game is played on the perimeter leaving the scoring area (the lane) as open as possible (it helps to not clog up the middle). The type of personnel on the court at any time will dictate mostly as to what offensive set the coach will use.

Coaches should remember that it is not what type of offence they use that is most important (although it has some importance in relation to the personnel in the team) but how they teach the execution of how to play. So many coaches turn out robots as players, particularly in the players early years. This constricts the development of the player and does not let him utilise any natural talent and athleticism he may have.

Remember that by teaching players first how to play according to the concepts of the game (movement into spaces, using peripheral vision to read the defence and to make good decisions, using angles and changes of direction) **will allow the players to be able to play**. When the skills, techniques and terminology of the game are added the players will understand better why they are important in the game. If the individual skills are taught first without an understanding of how to play, the players will tend to play like robots, as stated earlier. They will probably not use their vision for

good decision making and they will tend to make premeditated decisions or play only for themselves, rather than in a team concept.

The following lists include things that every offence, regardless of its' style, should have. If these are taught along with the concept and principles of offence to all players, then these players will be able to go anywhere and play for any coach with whatever style of offence and be productive.

Criteria for offences in beating the defence:

- create a side of the court (get the ball out of the middle)
- take the ball below the free throw line (flatten the defence)
- take the ball inside (make the defence collapse)
- reverse the ball

Rules for every offence:

- maintain good spacing
- maintain court balance
- movement of ball and players
- use patience and timing
- use good shot selection

**GOOD LUCK WITH YOUR TEACHING
AND REMEMBER THAT SPORT SHOULD BE ENJOYABLE
FOR THE PLAYERS AND THE COACH**

TEACHING THE CONCEPT AND PRINCIPLES OF DEFENCE THROUGH TEAM DEFENCE

The following article on Teaching Team Defence uses the *Concept of Defence* and the *Principles of playing defence*. Once players have learned this concept and these principles they will be able to play any style of defence (provided they also learn the necessary footwork and vision skills for defence). Without this knowledge of the concept and the principles, a player will not be able to play team defence and will remain playing as an individual or a robot (relying on coaches instruction or other cues to play). A list of the principles for playing defence are at the end of this article on Teaching Team Defence.

Teaching the concepts of defence.

The concept of defence is to stop the ball from getting closer to the basket (the scoring area). This concept is the same for all team sports and all net sports.

*Players should learn the concepts and principles of the game first and develop the skills to use within the concepts second. This allows them to be able to play immediately and importantly helps them to develop their natural talents. The principles of defence are listed under the section on **teaching team defence**.*

DRILL 1

1 on 1 from centre line

TEACHING POINTS AND EMPHASIS

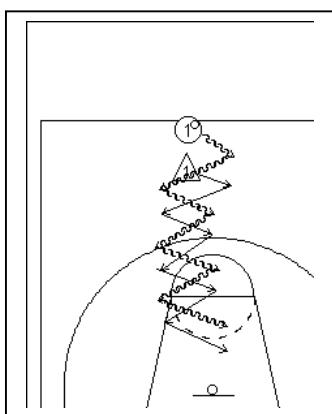

Have the player work in pairs starting at the centre line with the offence holding the ball and the defence playing between the ball and the basket. As the offence dribbles to the basket the defence tries to stay between the ball and the basket to stop the dribbler from getting closer to the basket (only lay-ups are allowed). Emphasise focusing on the ball and moving in the direction of the ball, not focusing on the offensive player and moving with him. The movement of the ball is the key to making the defence move and adjust. Have the players return to the centre line and alternate between offence and defence. Players will initially use all sorts of footwork but this is not important, but correcting them to move with the ball and playing between the ball and the basket is important.

DRILL 2

Footwork - Mass Defence Drill.

TEACHING POINTS AND EMPHASIS

Teaching the correct footwork next will allow the players to be able to make the best position. First have the players be able to move sideways across the court to their right and to their left. Correct stance is feet approximately shoulder width, knees bent, hands around the waist level, head up and maintained still. The body must remain square across the court and teaching the player to point each hip at a sideline will reinforce this. The only thing that the defence has to stop the ball with is their body (hands and arms cause fouls). To move right the player steps first with the right foot and to move to the left steps first with the left foot (this is the same movement for all athletic movement in offence and defence and

must be learned if the player is to maximise his talent). This allows the players to gain distance and move in that direction and helps to maintain balance. The toe of the foot must be pointed in the direction the player wishes to move. This allows the knee of that leg to point in that direction and provides maximum power from the leg in that direction. The initial step to move in a direction should be a longer stride but then is followed by short, sharp steps (allowing the player to maintain one foot on the floor and to be able to change in another direction quickly). Basketball is a running game, not a skipping, jumping, hopping game and so the movement is always as in running, with one foot on the floor at a time. Correct players who try to jump across the floor. The player's head should remain fairly level to the floor and if the player's head is bobbing up and down it is because he is jumping and not stepping, or his feet are coming

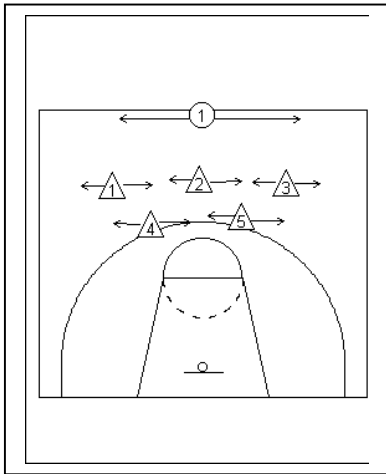

together (the feet should maintain the shoulder width stance). Emphasise short, sharp steps. Long strides are slower and do not allow for quick changes of direction. Increase the speed at which the players move and change direction. Have them work in short periods, around 10 seconds so as to maintain maximum work rate.

Now it is time to teach the player to move backwards and forwards. Since the concept of defence is to stop the ball from getting closer to the scoring area the player never moves directly backwards toward the basket, but rather backwards and sideways at the same time, always maintaining the body square across the court. To move backwards to the left the player moves his left foot back behind the level of the heel of his right foot and points his toe at the sideline (at right angles to maintain the hips to be pointed at the sidelines). Again step with the left foot first to move left. To change direction, moving forward or backwards

is exactly the same technique) the player makes a pivot on the leading foot and steps with the other foot in the new direction.

For example, when moving backwards to the left the player will pivot on his left foot and step backwards with his right foot in the new direction (placing the right foot just behind the level of the heel of his left foot and the toe of the right foot pointed at the sideline). This movement is a small reverse pivot and also termed a drop step.

To move forward the player uses the same technique, stepping with the foot in the direction he wishes to move, pointing the toe on that direction and maintaining his hips pointed at the sidelines. To change direction when moving forward the same technique as listed above is used, that is pivot on the leading foot and step in the new direction with the other foot.

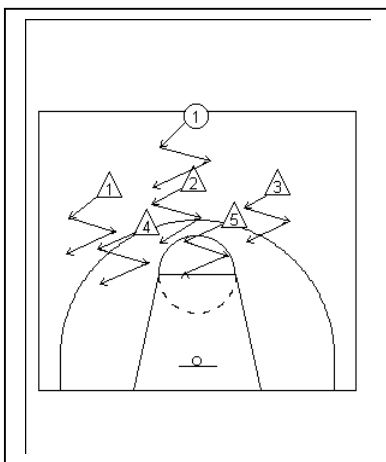

The Mass Defence Drill is an excellent drill to use early in every practice session as it allows the coach to correct the footwork and lifts the work rate of the players at the beginning of the session.

DRILL 3

1 on 1- (Progressive Defence Drill)

TEACHING POINTS AND EMPHASIS

Players pair up and the first pair start from outside the 3 point line and to the left of the offence. The defence should always maintain some space away from the offence so not get beaten with a quick step past his foot – about 1 ½ to 2 steps away depending on the distance from the basket, but never within 1 step. The offensive player can only use his right hand and must go to his right. The offence must be encouraged to beat the defence with his first step and go directly at the basket (not dribble to his right in a circle).

By pushing the ball to the floor on a dribble as the offence steps with his right foot he will be prevented from travelling and so practice correct driving technique in this drill. The defensive player moves with the ball. As the offence starts to take the ball to the right hand side of his body the defence must be moving left with a short step to maintain his body between the ball and the basket. As the offence releases the ball further to his right on the dribble the defence moves again to maintain the position between the ball and the basket.

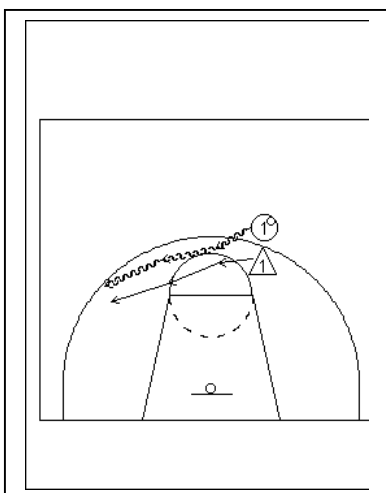

The defence must step across the court, not backwards as this will open up his body and a lane for the offence to penetrate to the basket. Basketball is about beating a player with the first step and if the defence can beat the ball to the spot where the offence wishes it to go then the defence will be able to win at this point. Of course as the dribbler continues to bounce the ball the defence must

continue to move to maintain the position between the ball and the basket and direct the ball toward the sideline. Since the concept of defence is to stop the ball from getting closer to the basket and the scoring area, the main objective of the defence must be to keep the ball out of the lane and force it further from the basket. The easiest place to score from is in the lane and by forcing the ball away it makes the offence shoot from outside, therefore reducing their chances of scoring.

Once the first pair has finished the next pair starts and so the drill continues. The coach can have the players who have finished stand on the other side of the court and then come back with the left hand from the right hand elbow. In this way the players will learn to move both left and right, in offence and in defence.

The drill is called progressive as later when the players can defend the ball from the initial position on the court they can start from a position between the elbow and the sideline and then later from out near the sideline. Obviously the more space that the offence has to move into the more difficult is it for the defence to defend the lane.

DRILL 4

1 on 1 - (Progressive Defence Drill)

TEACHING POINTS AND EMPHASIS

Next players should be taught to use their hands. First the defence must understand what the offence is able to do with the ball when it is in each position. For example when the offence has the ball on his right side near his hip area he can only do two things – either pass the ball right or dribble to his right. If he wants to pass left or dribble left then the ball must be taken to the left-hand side of his body. Should this happen then the defensive player must move with the ball to that side. When the offence has the ball on his right side the defensive player should have his left arm out straight with the palm facing forward and the right arm in an arm bar against the bottom of his ribs. The arm bar is used to protect on any contact and to be able to bump off the offence and maintain some space between away from the offence so that the offence cannot spin on him. The drill continues with the defence now using his arms and hand to protect against the quick one handed pass and to be able to bump off and maintain spacing.

DRILL 5

1 on 1 half court - (slide, run, slide)

TEACHING POINTS AND EMPHASIS

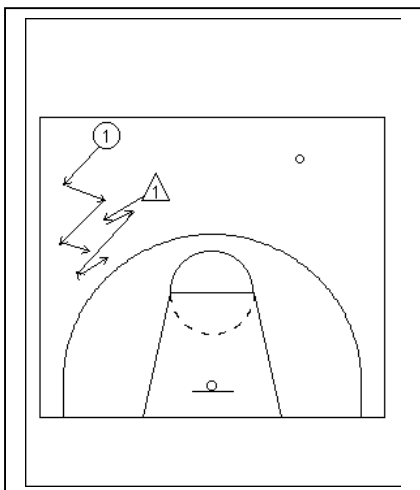

When defending against the ball handler in the area around and within the 3 point line the above footwork is used. When the ball handler is outside this area and further up the court, he has more room in which to move it is more likely that the offence will beat the defence and so the defence needs to learn how to catch up when he is beaten. The defence will need to run to catch up and then assume the defensive stance again quickly. We call this learning to slide, run, slide. Players should practice this, down the full length of the court without any offence initially to get their footwork correct. When the defence runs he must use a lateral movement, that is feet pointed in the direction he wants to run and his body turned toward the dribbler. Correct footwork to pivot and run and to pivot and slide must be taught (the concept of stepping with the correct foot to go left or right will assist this). When pivoting the offensive player must always turn to see (face) the inside of the court. Then a half court sideline drill can be used to practice against a dribbler.

Next the players should learn how to channel the dribbler. This skill requires lateral running and the defence tries to keep the dribbler against one sideline and not allow him to dribble the ball into the middle of the court. To do this the defence runs

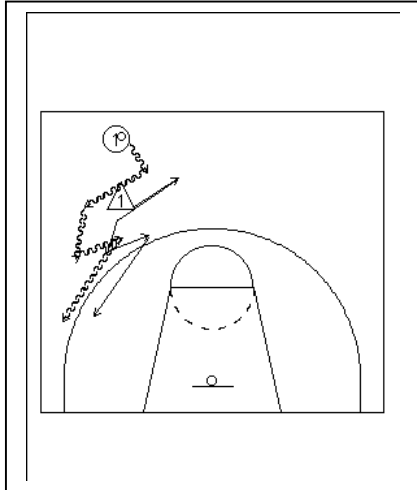

with his trailing shoulder level with the leading should of the dribbler and is ready to stop and slide back in the opposite direction should the dribbler stop and try to change direction into the middle of the court. The defence should be about 1 ½ to 2 steps away from the ball so not get beaten with a quick change of direction, especially a spin move. Full court drills may be used to teach and practice this skill. The offensive player must start to one side of the court and try to beat the defence from baseline to baseline, by dribbling past him on the sideline or coming inside the defence to the middle of the court. The defensive player uses the above footwork to stop the ball coming inside the court and also to keep the ball against the sideline. At the scoring end the offence should try to score a lay-up and the defence should try to stop the ball getting into the lane for this lay-up.

Teaching team defence.

CONCEPTS AND PRINCIPLES OF TEAM DEFENCE

All players need to learn the concepts and principles of offence and defence. These principles apply to all types of offence and defence. With a good understanding of and an ability to play these, a player will be able to play all types of offences and defences. Without this understanding and ability a player becomes robotic or premeditates his actions.

There are 3 areas for a player to develop: *SKILLS, UNDERSTANDING HOW TO PLAY and DECISION MAKING*. Of these 3 areas, the most important for a player to learn initially are understanding how to play and decision making. Skills take a much longer period to develop (approx 10 years to develop all skills to a high level), however they should obviously start to be introduced early in development to allow the player to have some competence and confidence in playing.

These concepts and principles apply to all court and field sports and all net sports.

DEFENCE

Concept

The concept of defence is: **stop the ball**. Stop the ball from getting closer to the scoring area. It is the ball we must stop, not players, as it is the ball that scores.

Principles

Playing on-ball

- Play between the ball and the basket (not between the player and the basket)
- Always move with the ball (at the same time as the ball) and in the same direction as the ball (parallel to the ball movement)
- Force the ball away from the 80% scoring area (the lane/key) and toward the sideline (enables the defence to deny passes into the lane and force the ball out on top – away from the basket)
- Give up an outside shot in favour of protecting against a shot in the lane/key

Playing off-ball

- Always play the principles of “help and recover defence”, the basic principles of all team defences
- Always play in a triangle between your player (or the player/s in your area in a zone defence) and the ball. The closer your player is to the ball, the flatter is your triangle and the closer you should be to your player. The further your player is from the ball, the deeper is your triangle and the further you can be from your player
- Always see your player and the ball (do not look at the ball) and the court

- Always move with the ball (at the same time as the ball) and in the same direction as the ball (parallel to the ball movement)
- When your player is on the ball side of the split line (the imaginary line between the two baskets – “splits” the court into ball side and help side), play in a flat triangle toward your player. When your player is on the help side, play in a deeper triangle, further from your player, with at least one foot on the split line. Always help against penetration of the ball into the lane/key from the help side. Never help from the ball side
- Recognize that the most dangerous offensive player is the player with the ball. The second most dangerous player is the player closest to the ball and/or basket. The next most dangerous player is that next closest to the ball/basket, etc. Protect against the most dangerous and second most dangerous first
- When your defence breaks down on a turnover or against a fast break play “Scramble Defence” principles (refer to the notes on the most dangerous player above)

ALL team defences played in basketball are based on the principles of Help and Recover Man to Man Defence, that is all half court defences (man or zone – all types of zones) and all extended defences. So it is important that all players must learn these principles of help and recover defence at the beginning. Players who cannot understand and play to these principles cannot play any style of team defence. These principles are based on the concept of stopping the ball and all defensive players are positioned to be able to help stop the ball or to be able to rotate to a more threatening offensive player than their own. The full teaching points on this concept are given later. Also is a section on teaching close out techniques (the footwork of moving forward in defence mentioned under footwork in this session is the basis of this). Now it is time to start to teach team defence. The following drills help to teach Help and Recover Man to Man Defence.

DRILL 6

2 on 2 help and recover man to man defence
(half court)

TEACHING POINTS AND EMPHASIS

By extending drills to half court the players can start to learn about extended defence and turning the dribbler, run and jump switches and recovering to a line below the ball. Stress to all players to move in the same direction as the ball and at the same time as the ball.

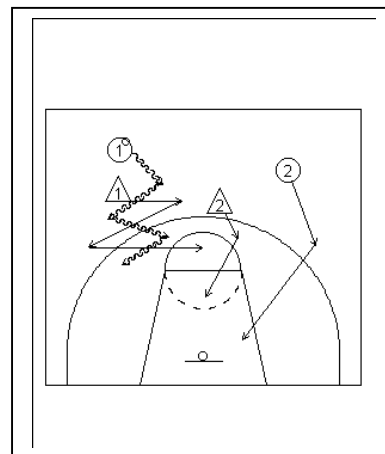
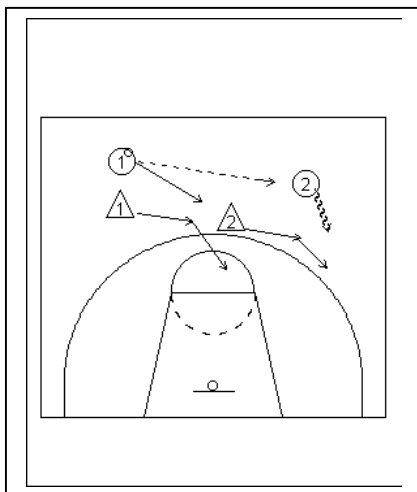

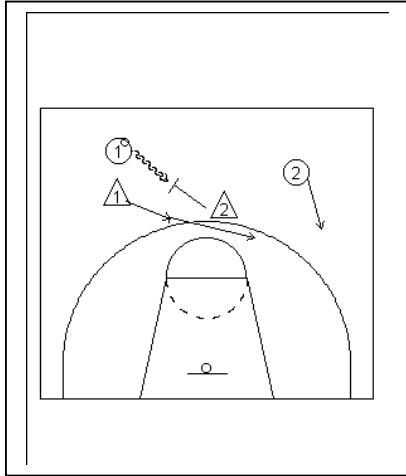

DRILL 7

2 on 2 help and recover
man to man defence (full court)

TEACHING POINTS AND EMPHASIS

Now we can extend the drills to full court and add another defensive player (2 offence versus 3 defence) and teach rotations and trapping (channeling and trapping).

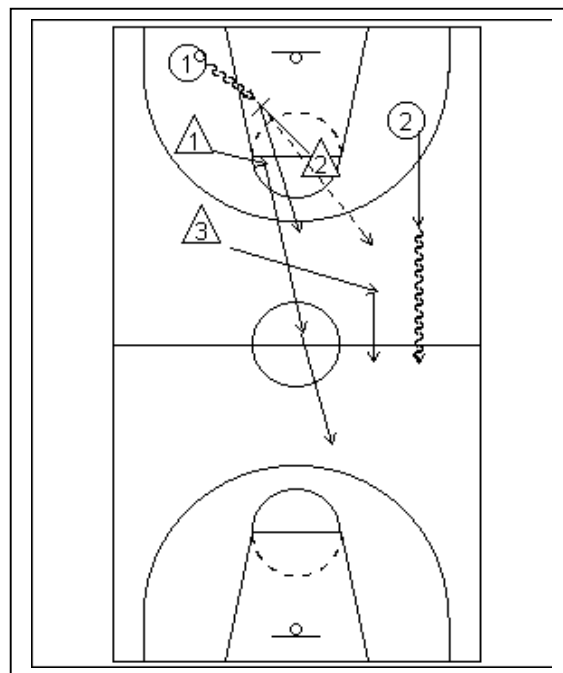

Man to man defence with the principles of Help and Recover

The principles of “Help and Recover Defence” are to have all players in a position to defend against the ball and be in a position to stop the player they are defending from cutting over the top of them (that is cutting between the defender and the ball). This means that the player who is defending the ball (called on-ball defence) players between the ball and the basket and all other players defending a player away from the ball (called off-ball defence), play in a triangle between their player and the ball.

On-ball defence was referred to in the earlier drill on 2 on 2 (Progressive Defence drill). For off-ball defence the position of the defensive player is determined by the closeness of their player to the ball and the basket.

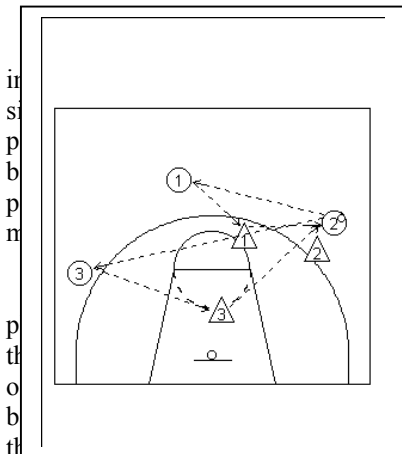

ology and teaching points for the defensive players. The “split line” is the line that divides the court into ball side (the side where the ball is) and the help side (the side where the ball is not). The use of the split line is an important concept in positioning defensive players. Above the free throw line, the help side players must have their feet closest to the ball so that they will be close enough to help stop the ball on a drive and yet be in a position to help stop the ball on a shot. When the ball is below the free throw line the help side defensive players must be in a position to stop the ball on a drive.

To understand the concept of the most dangerous player, the second most dangerous player, and the third most dangerous player. The MOST DANGEROUS player on the court, for a given situation, is the player closest to the ball and the basket (it is only he that can score). The second (next) most dangerous player is the player closest to the ball and the basket who is furthest from the ball and the basket. The third is the next player closest to the ball and the basket who is furthest from the ball and the basket. If the offence has a low post player, he will be the second most dangerous player and so his defence will never leave him to help on a drive or shot, except in an absolute emergency.

The next teaching point is that ONLY the players from the help side of the court will move to help stop the ball on a drive when their team mate is beaten (the beaten team mate should always stay with the dribbler even if beaten). The players on the ball side of the court should NEVER try to help stop the ball on a drive. If they leave their player, then a quick shot will be available (these players will be the next most dangerous players as they are closest to the ball and the basket). Later this article outlines how the players will rotate on a help situation so that the defensive team can move to cover the next most dangerous players when beaten.

DRILL 8

3 on 3 help and recover
man to man defence (half court)

TEACHING POINTS AND EMPHASIS

The closer the off-ball defensive player’s man is to the ball the closer he is to his man and the line between the ball and his man, called a flat triangle. The triangle is formed by the lines from the ball to his man, his man to himself and from himself to the ball. The further the defender’s player is away from the ball and the basket then the deeper can be his triangle as he will have time to recover to his man on a longer pass. All defensive players must move in the same direction as the ball (that is parallel to the ball movement, be it a pass or a dribble) and at the same time as the ball moves, to be in the new position by the time the ball arrives at the next player/spot.

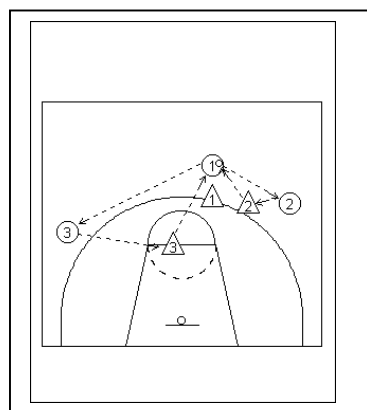
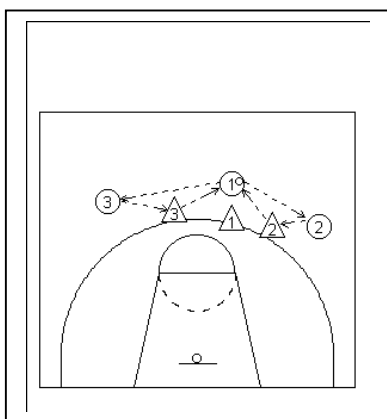

From here the coach needs to teach the principles of “Help and Recover” man to man defence using The Shell Drill. Coaches should start with 3 on 3 and move to 4 on 4. They should build up in skills from adjusting to the ball to catch and drive and then defending the cutter (pass and cut).

DRILL 9

4 on 4 help and recover
man to man defence
Shell Drill - adjust to the ball (pass)

TEACHING POINTS AND EMPHASIS

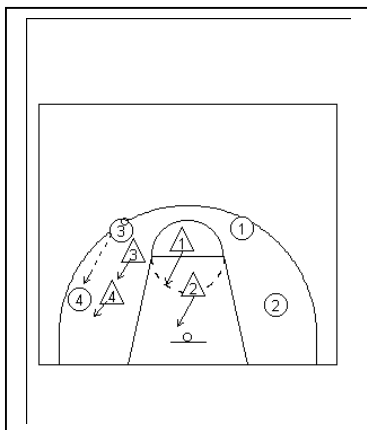
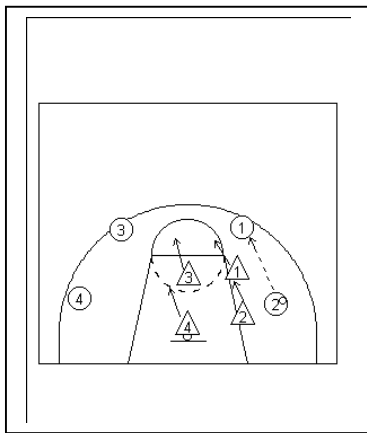
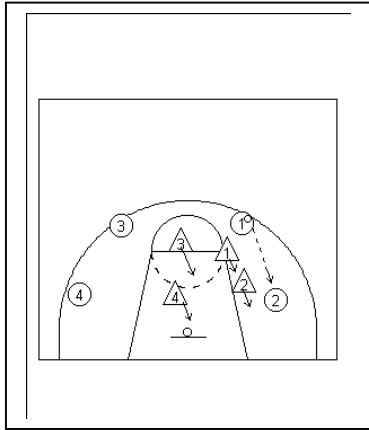

The 4 offensive players play 1-2 steps inside the 3 point arc (in a stationary position) and the 4 defenders play in a man to man situation. As the ball is passed (slowly at first) from offensive player to player, the 4 defensive players each adjust to the movement of the ball, by moving in the same direction as the pass (ie parallel) and at the same time as the pass. Each defensive player should arrive at the new position by the time the ball arrives at the next offensive player. If coaches do not start with slow passes, the defensive players will never get the idea of how to make the new position. As footwork quickens the passes can quicken. Stress that the defensive players must keep vision on their man AND the ball (see man and ball). Emphasis to the defence to move in relation to the ball (direction and speed), so that they are in the correct position in their triangle.

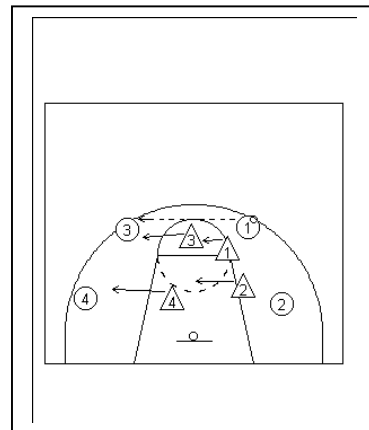

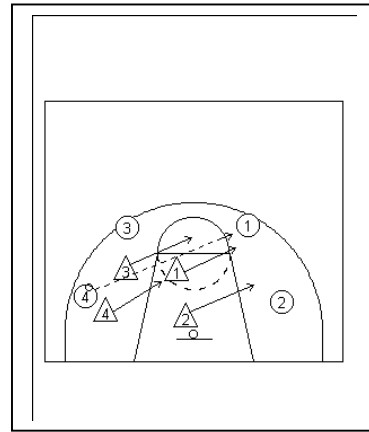
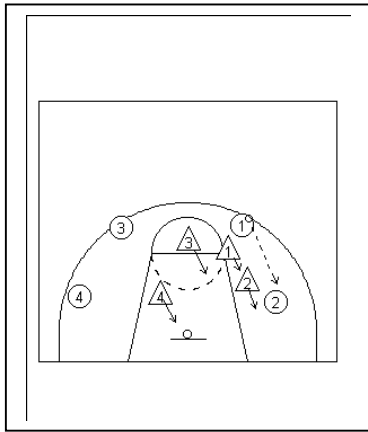

DRILL 10

4 on 4 help and recover man to man defence
 Shell Drill – pass and cut (give and go)
 – bump/stop the cutter

TEACHING POINTS AND EMPHASIS

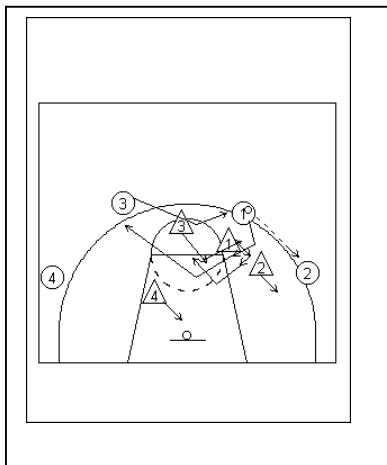

In this drill each defensive player learns to stop the passer from cutting between him and the ball. To do this, the defensive player must play by the principles outlined earlier, that is move in the same direction as the pass (ball) and at the same time to get into his triangle. Now as the offensive player tries to get between him and the ball on the cut (called cutting over the top of the defence), the defensive player will step up into the path of the offensive cutter and force him to go behind the defence. This is called bumping the cutter (although not always will there be contact on the cutter) and now the defensive player stays between the ball and the offensive player and prevents him from getting an easy pass with the ball. A pass and cut is the simplest team move in basketball and it is imperative that the defensive player stops this move, which is an integral part of all team offence. Of course all other defensive players must adjust to the ball (remember to stress seeing the ball and their man).

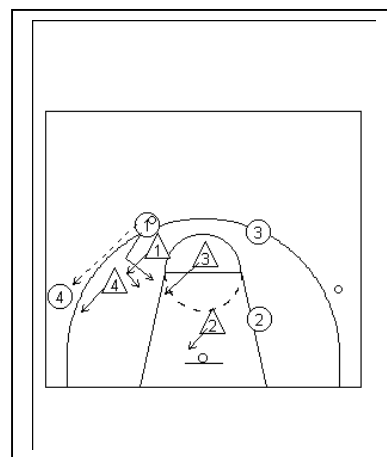
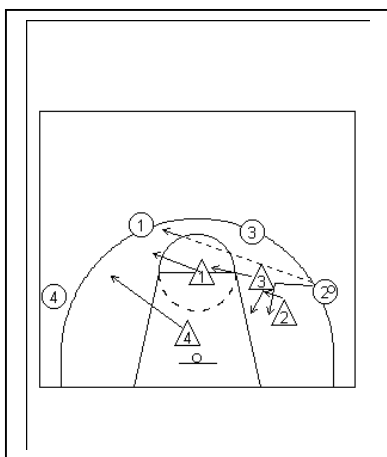

DRILL 11

4 on 4 help and recover man to man defence
close out drill recover to stop the drive

TEACHING POINTS AND EMPHASIS

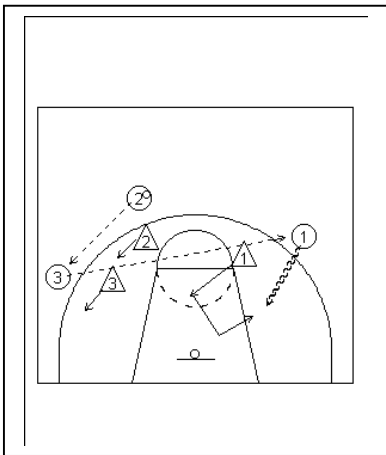
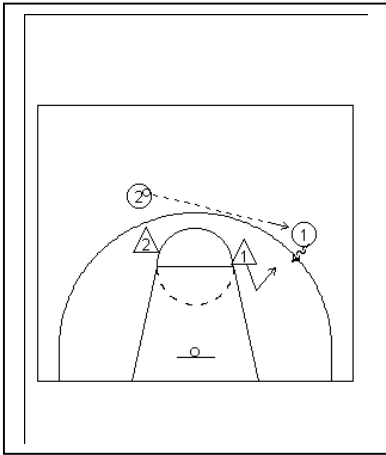

Sometimes in play the defensive player will be caught out of position when his man receives a pass and makes a quick drive to the basket. This also may happen when a defensive player goes to help on a team mates man on a drive. In this situation the defensive player moving to stop the drive must first recover to the line between the ball and the basket to stop the ball. If the defensive player tries to move toward the dribbler, then the dribbler will explode past him, or he will be forced to foul the dribbler to stop the penetration. The principle of recovery is to move to the line between the ball and the basket and ahead of the ball so that the defensive player can stop a lay-up. In some cases the defensive player may need to then move forward to stop an outside shot. The movement should be to run to the line between the ball and the basket and then shuffle forward. The defensive player may have his inside foot forward if the ball is to be directed toward the sideline or the outside foot forward if the ball is to be directed toward the middle of the court. On the shuffle steps the defensive player must stay low with feet a little wider and take quick, stutter steps.

DRILL 12

4 on 4 help and recover man to man defence
- defensive rotation on help side drill

TEACHING POINTS AND EMPHASIS

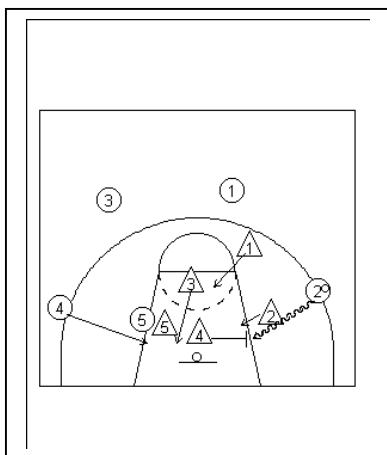

On a drive toward the basket and the on-ball defensive player is beaten this defensive player must still stay with the dribbler and someone else must come from the help side of the court to stop the ball. It is IMPORTANT to teach the defence that help in such situations help must ONLY come from the help side of the court and NEVER from the ball side of the court. The reason for this is that the offensive player on the ball side is most likely the next most dangerous player on the court and if his defence leaves him to help then a quick and easy shot may become available for the offence. Of course when a player from the help side comes to help his player will become free for a pass. This requires the defence on that side of the court (the help side) to rotate down to cover this situation (maybe the next most dangerous player) and if necessary leave his man on the outside open for a shot. The philosophy is to stop the lay-up and if necessary

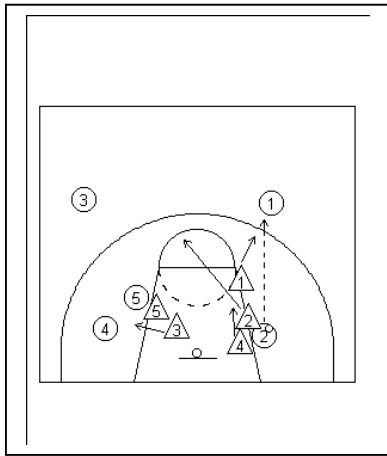
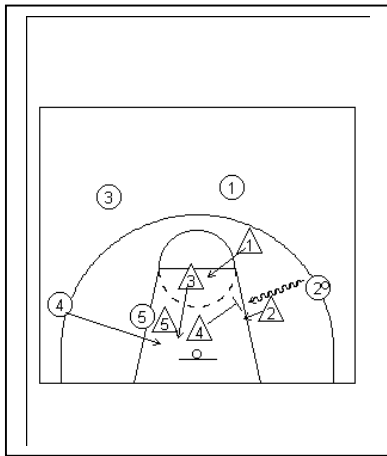

to give up a shot then give up an outside shot as the preference. Provided that all defensive players move at the same time as the ball and in the same direction as the ball, they will be in a position to help and rotate. Of course as in all team work communication is the key to success. Vision is also important for good decision making. On a drive through the side of the lane (key) and the baseline area the help defence will come from the back of the defence (that is come up from the basket). On a drive through the top of the lane (key) – ie through the free throw line, the help defence should be able to come from the guard area. The diagrams show this rotation. The next important step is to teach players how to rotate out when the ball is passed back outside. The philosophy here is that the inside defensive players who are between the offence and the basket should stay with that player and the defensive player who is not must rotate out. This allows the team to defend the next most dangerous players (ie those closest to the basket). Again the diagrams show this. The low post defence never leaves his player as this is always the next most dangerous player.

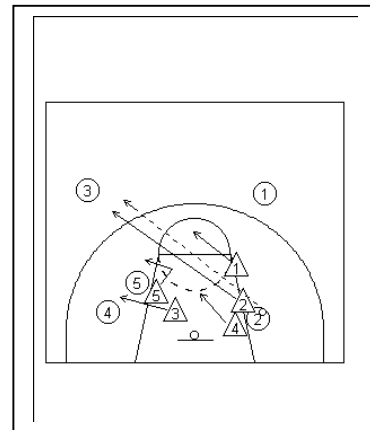

DRILL 13

4 on 4 help and recover man to man defence
Shell Drill – catch and drive

- stop the ball from penetrating into the key/lane

TEACHING POINTS AND EMPHASIS

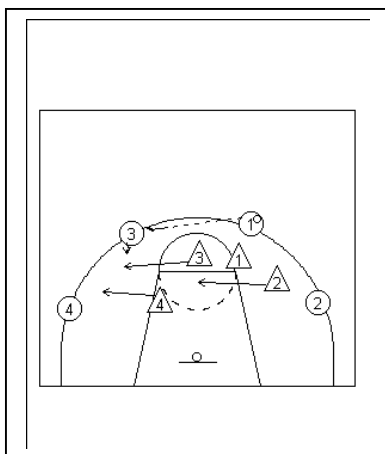

In this drill the on-ball defensive players learns to stop the ball from penetrating on a dribble into the lane and the other players learn to adjust to the ball movement to be in a position to help stop the ball, if needed. The defensive player who is recovering to his man, that is moving to be on-ball, must recover to the line between the ball and the basket and then move with the ball (remember the Progressive Defence Drill) to stop the drive. Now the coach teaches the off-ball players how to help stop the ball when the on-ball defence is beaten on the drive. ONLY the players on the help side should move to stop the ball (NEVER try to help stop the ball from the ball side of the court, because these players are the next most dangerous players being closer to the ball and the basket). In the initial teaching the coach must demand that the player

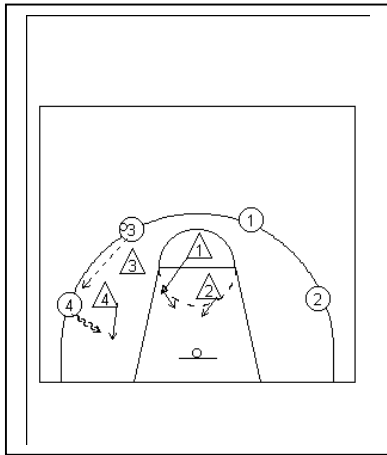

receiving the pass tries to beat the defensive player on the drive before passing off to a team mate. In this way the drill is competitive and more game like. When the driver makes a pass (dishes off) all defensive players must once again quickly adjust to the ball movement (see man and ball at all times). Now the defence can use help and recover techniques to stop the penetration of the ball and rotate out after helping (ONLY when necessary to help).

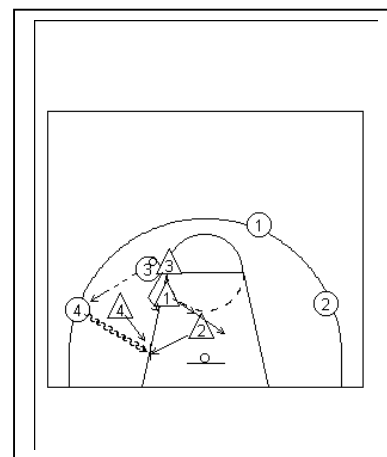
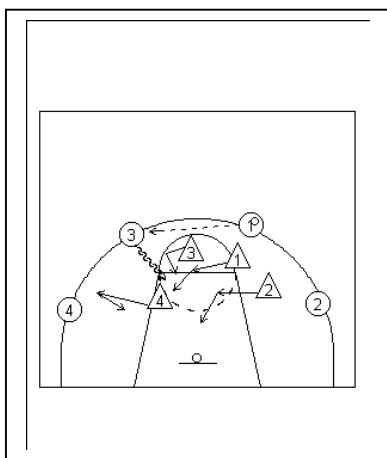

The coach can now have the team play half court 4 on 4 with all normal aspects of and stop to correct as necessary. Obviously these shell drills will need to be repeated at several practice sessions until the players are capable of executing good help and recover team defence.

The use of the mass defence drill in the early part of every practice session is a good idea as the players get top practice footwork (helps with offensive footwork also) and they will be practicing explosive movement and be ready to work intensively at other drills. The use of the breakdown drills of the shell drill should be a regular inclusion at practice sessions and are used by the better elite teams also.

Of course the coach will need to teach individual defence against the low post and high post player. With the approach of many coaches to teach all player to be able to play in these positions, it is also obvious that coaches should teach all players how to play defence against these positions.

Now the players can practice playing in a 5 on 5 situation. They are also ready to learn other team defences skills, such as full court man to man defence, half court zone defences and extended zone defences. Remember that the principles of help and recover defence are the base for all these team defences and so must be taught before trying top play any of these.

By teaching players how to play first - the concepts of the game (offence and defence) will allow the players to be able to play and when the skills, techniques and terminology of the game are added the players will understand better why they are important in the game. If the individual and team skills are taught first without an understanding of how to play, the players will tend to only play for themselves, rather than in a team concept.

Criteria for beating team offences and rules for executing team defences:

- prevent penetration of the ball into the lane
- deny close passes
- shoot the gap on all cross court passes
- protect firstly against the player with the ball and the next most dangerous player
- adjust position according to movement of the ball and the player
- make the adjustment while the ball is in the air
- force the ball toward the sideline or back out top
- play “lanes” and “stops” to create pressure

**GOOD LUCK WITH YOUR TEACHING
AND REMEMBER THAT SPORT SHOULD BE ENJOYABLE FOR THE PLAYERS
AND THE COACH.**